

UP-4slim Compact Installation Loudspeaker

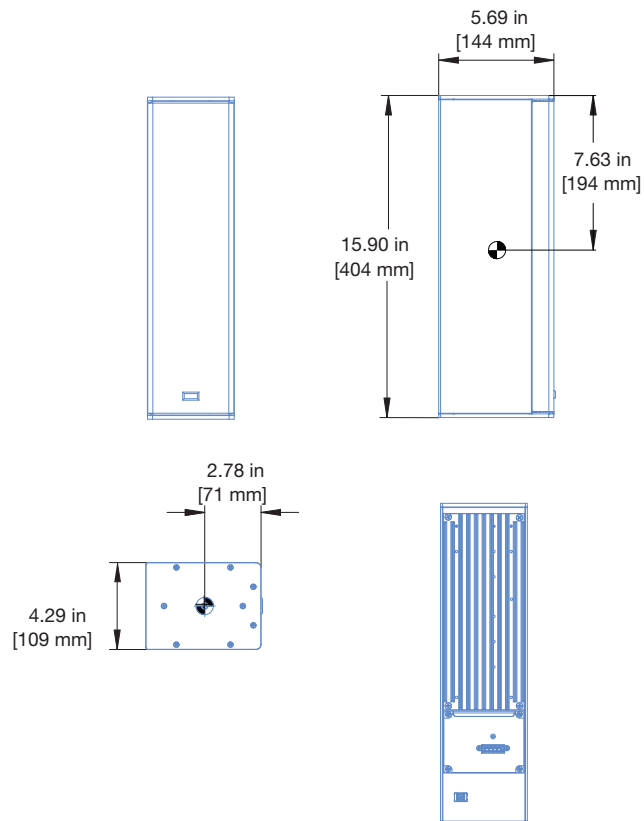

The UP-4slim ultra-compact installation loudspeaker is ideally suited for applications requiring a small, slim, aesthetically pleasing cabinet that delivers high sound pressure levels with low distortion and uniform coverage. The UP-4slim offers this exceptional audio performance in a compact self-powered package with a remote power supply. As a standalone loudspeaker, the UP-4slim is appropriate for vocal reinforcement, front-fill, and under balcony fill applications. The UP-4slim can be optionally paired with a Meyer Sound subwoofer to create a full-range system. One MM-10ACX can also power one UP-4slim.

The UP-4slim is engineered to the same award-winning standards as all Meyer Sound IntelligentDC loudspeakers. Its on-board amplification and sophisticated signal processing provide the flat frequency and phase responses for which Meyer Sound loudspeakers are known. Its drivers are designed and manufactured at the Meyer Sound factory in Berkeley, California.

The UP-4slim's high-frequency section includes a 1-inch metal dome tweeter on a constant-directivity, high-frequency horn. The low to mid-frequency section includes two 4-inch cone transducers that work in parallel at low frequencies to deliver a combined acoustic output. One of the drivers rolls off at higher frequencies to maintain constant directivity in the crossover region.

The UP-4slim has very low distortion, boasts a wide operating frequency range (65 Hz – 18 kHz), and linear peak SPL of 116.5 dB with crest factor >16.5 dB using M-noise⁴. With a smooth and consistent 100° coverage, fewer loudspeakers can cover a larger area, reducing system cost while maintaining the highest sound quality.

With IntelligentDC technology, the UP-4slim receives DC power and balanced audio from a single Phoenix™ 5-pin connector. Powering the loudspeakers from a Meyer Sound IntelligentDC external power supply eliminates the need for wiring conduits while still preserving the advantages of self-powered systems.

The Meyer Sound IntelligentDC power supplies distribute DC power and balanced audio to UP-4slim loudspeakers or other Meyer Sound IntelligentDC loudspeakers. The UP-4slim's amplifier and signal-processing circuits store DC power and tolerate voltage drops, thereby accommodating light-gauge cables and lengthy cable runs. Composite multiconductor cables, such as Belden® 1502 or equivalent, can deliver both DC power and balanced audio to loudspeakers at cable lengths up to 150 feet with just 1 dB of loss in peak SPL using 18 AWG wire for power. Longer cable lengths are possible with heavier gauge wires. The 2-channel MPS-482HP power supply is ideal for applications requiring a small channel count or the capability for mounting the supply remotely on a wall or ceiling, while the 8-channel MPS-488HP is ideal for larger installations. The MPS-488HP can be optionally purchased with an RMS module for connecting to Meyer Sound's remote monitoring system.

UP-4slim options include weather protection and custom color finishes for installations with specific cosmetic requirements. Mounting options include the MUB-UP-4slim U-bracket, MYA-UP-4slim cradle-style yoke, the PAS-M8 Adapter Sleeve, and the MSA-STAND Adapter Cup 35 mm. The top and bottom rigging plates have M8 threads. The grille frame is made from powder-coated, stamped steel, and the box-shaped, vented enclosure is aluminum.

FEATURES AND BENEFITS

- Extraordinary fidelity and power in a compact aluminum package
- Low distortion drivers and a metal dome tweeter deliver a smooth high-frequency response
- Wide, symmetrical coverage pattern creates a broad listening area
- Unique crossover design eliminates comb filtering and yields a consistent midrange response
- Exceptional SPL-to-size ratio
- Design supports long cable runs with light-gauge cables

APPLICATIONS

- Front-fill and under-balcony fill coverage
- Theatrical sound reinforcement and special effects
- Installed Audio/Visual systems
- Compact voice reinforcement systems
- Constellation Acoustic Systems

ACCESSORIES AND ASSOCIATED PRODUCTS

MUB-UP-4slim U-Bracket: U-shaped mounting bracket accommodates mounting of the UP-4slim on a ceiling, wall, or floor at any angle.

MYA-UP-4slim Yoke: Suspends one UP-4slim from a single point. In addition, the yoke may be mounted onto a 35 mm pole to facilitate easy panning and tilting using the optional MSA-STAND Adapter Cup.

MSA-STAND Adapter Cup 35MM: The MSA-STAND Adapter Cup can be used to mount the MYA-UP-4slim yoke onto a 35 mm pole.

PAS-M8 Adapter Sleeve: 35 mm pole Adapter Sleeve to enable pole mounting of loudspeakers with M8 rigging points. This adapter has a threaded M8 end that screws directly into a loudspeaker's M8 rigging point. A knob on the 35 mm side secures it to a pole.

MPK-POLE-35MM-M20 Adjustable Pole Kit: Adjustable length 927–1524 mm (36.5–60 in) pole with assisted lift. Lower shaft fits 35 mm cups or use the removable M20 threaded lug for added stability. Upper shaft includes the PAS-M20 Adapter Sleeve to fit loudspeakers with 35 mm and M20 internal pole mounts onto a 35 mm speaker stand, and the PAS-M8 Adapter Sleeve to fit loudspeakers with M8 rigging points onto a 35 mm pole. Additional 38 mm (1.5 in) adapter included.

Galileo GALAXY Network Platform: The Galileo GALAXY Network Platform provides state-of-the-art audio control technology for loudspeaker systems with multiple zones. With immaculate sonic performance, it provides a powerful tool set for corrective room equalization and creative fine-tuning for a full range of applications.

MPS-488HP External Power Supply: Rack-mount unit that delivers balanced audio and high-current DC power to up to eight loudspeakers; version available with RMS remote monitoring system.

MPS-482HP External Power Supply: 1RU 1/2 width rack unit that delivers balanced audio and high-current DC power to up to two audio channels; rack mount or use available options to mount on ceiling, wall, pole or truss configurations.

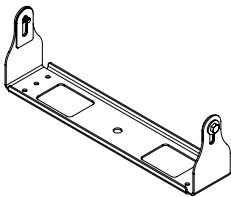

MUB-UP-4slim U-Bracket



MYA-UP-4slim Yoke

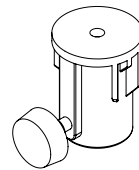

MSA-STAND Adapter Cup 35MM

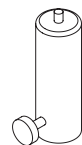

PAS-M8 Adapter Sleeve

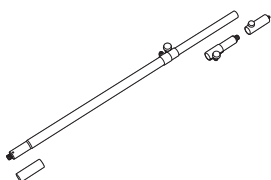

MPK-POLE-35MM-M20
Adjustable Pole Kit



Galileo GALAXY Network
Platform

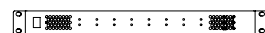

MPS-488HP External Power
Supply

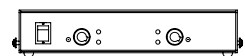

MPS-482HP External Power
Supply

SPECIFICATIONS

ACOUSTICAL ¹	
Operating Frequency Range ²	65 Hz – 18 kHz
Frequency Response ³	70 Hz – 18 kHz ±4 dB
Phase Response	102 Hz – 18 kHz ±45°
Linear Peak SPL ⁴	116.5 dB with crest factor >16.5 dB (M-noise) , 109.5 dB (Pink noise), 112.5 dB (B-noise)
COVERAGE	
Horizontal Coverage	100°
Vertical Coverage	100°
TRANSDUCERS	
Low Frequency	Two 4-inch cone drivers; 4 Ω nominal impedance
High Frequency	One 1-inch metal dome tweeter; 8 Ω nominal impedance
AUDIO INPUT	
Type	Differential, electronically balanced
Maximum Common Mode Range	±5 V DC
Connectors	Phoenix 5-pin male
Input Impedance	10 kΩ differential between Audio (+) and Audio (-)
Wiring	Pin 1: DC Power (-) Pin 2: DC Power (+) Pin 3: Audio Shield, Chassis/earth Pin 4: Audio (-) Pin 5: Audio (+)
Nominal Input Sensitivity	-2.0 dBV (0.8 V rms) continuous is typically the onset of limiting for noise and music
Input Level	Audio source must be capable of producing of +16 dBV (6.31 V rms) into 600 Ω to produce the maximum peak SPL over the operating bandwidth of the loudspeaker.
AMPLIFIER	
Type	3-channel, Class-D with integral advanced digital signal processing
Total Output Power ⁵	500 W peak
THD, IM, TIM	< 0.02%
Cooling	Convection
DC POWER	
Connector	Phoenix 5-pin male provides power and audio connection (see Wiring above)
Safety Agency Rated Voltage Range ⁶	48 V DC (Meyer Sound IntelligentDC External Power Supply Required)
DC CURRENT DRAW ⁷	
Idle Current	0.23 A average
Maximum Long-Term Continuous Current (>10 sec)	1.00 A average
Maximum Instantaneous Peak Current	4.5 A peak
PHYSICAL	
Dimensions	W: 4.29 in (109 mm) x H: 15.90 in (404 mm) x D: 5.69 in (144 mm)
Weight	14 lb (6.35 kg)
Enclosure	Aluminum with slightly textured black finish
IP Rating	Weather-protected version rated IPx5 with properly installed rain hood. See the UP-4slim Operating Instructions available at meyersound.com/documents .
Protective Grille	Powder-coated, stamped steel with black mesh
Rigging	Top and bottom aluminum plates with M8 threads

NOTES

1. Loudspeaker system predictions for coverage and SPL are available in Meyer Sound's MAPP System Design Tool.
2. Recommended maximum operating frequency range. Response depends on loading conditions and room acoustics.
3. Free-field, measured with 1/3 octave frequency resolution at 4 m.
4. **Linear Peak SPL** is measured in free-field at 4 m referred to 1 m. Loudspeaker SPL compression measured with M-noise at the onset of limiting, 2-hour duration, and 50 °C ambient temperature is < 2 dB.

M-noise is a full bandwidth (10 Hz–22.5 kHz) test signal developed by Meyer Sound to better measure the loudspeaker's music performance. It has a constant instantaneous peak level in octave bands, a crest factor that increases with frequency, and a full bandwidth Peak to RMS ratio of 18 dB. The presence of a greater-than (>) symbol with regard to crest factor indicates it may be higher depending on EQ and boundary loading.

Pinknoise is a full bandwidth test signal with Peak to RMS ratio of 12.5 dB.

B-noise is a Meyer Sound test signal used to ensure measurements reflect system behavior when reproducing the most common input spectrum, and to verify there is still headroom over pink noise.

5. Peak power based on the maximum unclipped peak voltage the amplifier will produce into the nominal load impedance.
6. Tolerates voltage drops up to 30% due to long cable runs. Normal operating conditions with recommended cable gauge and length assures peak SPL remains within 2 dB of max SPL specification.
7. Current draw measured at 48 V DC.

ARCHITECTURAL SPECIFICATIONS

The loudspeaker shall be a self-powered, full-range system; the transducers shall consist of two 4-inch low-frequency cone drivers and one 1-inch high-frequency metal dome tweeter. The loudspeaker system shall incorporate internal processing electronics and a three-channel amplifier, one channel for each driver. Processing functions shall include equalization, phase correction, signal division, and driver protection. Amplifier channels shall be class D. Amplifier output power shall be 500 W total for all three channels. Distortion (THD, IM, TIM) shall not exceed 0.02%.

Performance specifications for a typical production unit shall be as follows, measured at 1/3-octave resolution: operating frequency range shall be 65 Hz – 18 kHz; phase response shall be 102 Hz – 18 kHz $\pm 45^\circ$; linear peak SPL shall be 116.5 dB with crest factor >16.5 dB, measured with M-noise, free field at 4 meters and referred to 1 meter. The horizontal and vertical coverage shall be 100°.

The loudspeaker shall be equipped with a Phoenix 5-pin male connector

(three pins for balanced audio and two pins for DC power). The audio input shall be electronically balanced with a 10 k Ω impedance and accept a nominal -2.0 dBV (0.8 V rms) input signal.

Power requirements for the loudspeaker shall be a Meyer Sound IntelligentDC power supply capable of delivering 48 V DC. Maximum long-term continuous current draw for the loudspeaker (> 10 s) shall be 1.0 A average at 48 V.

All components shall be mounted in an acoustically vented box shaped enclosure constructed of aluminum. Top and bottom shall incorporate M8 threads. The front protective grille shall be powder-coated, stamped steel.

Dimensions for the loudspeaker shall be W: 4.29 in (109 mm) x H: 15.90 in (404 mm) x D: 5.69 in (144 mm). Weight shall be 14 lb (6.35 kg).

The loudspeaker shall be the Meyer Sound UP-4slim.