

# RMServer



***Keep this important user guide.  
Check [www.meyersound.com](http://www.meyersound.com) for updates.***

---

© 2014

Meyer Sound Laboratories, Inc. All rights reserved.

Compass RMsServer/Remote Monitoring System Hardware Guide, PN 05.222.024.01 A

The contents of this manual are furnished for informational purposes only, are subject to change without notice, and should not be construed as a commitment by Meyer Sound Laboratories Inc. Meyer Sound assumes no responsibility or liability for any errors or inaccuracies that may appear in this manual. Except as permitted by applicable copyright law, no part of this publication may be reproduced, stored in a retrieval system, or transmitted, in any form or by any means, electronic, mechanical, recording or otherwise, without prior written permission from Meyer Sound.

MEYER SOUND and the Meyer Sound wave logo are trademarks of Meyer Sound Laboratories Inc. and are registered in the United States Patent and Trademark Office, as well as in other countries.

The following is a partial list of additional Meyer Sound trademarks and service marks:

650-P\*, 650-R2\*, Acheron\*, AlignALink, BroadbandQ\*, CAL, Callisto, Compass\*, Compass RMS, Composite EQ, Constellation\*, CueConsole, CueStation, D-Mitri\*, EXP\*, Galileo\*, GuideALink, Intelligent AC, LCS, LEO, LEO-M, M Series, M1D, M2D, M3D, MAPP Online Pro\*, Matrix3, MatrixLink, M'elodie\*, Meyer Sound MAPP Online, MICA\*, MILO\*, MINA, MSL-4\*, MultiSense, QuickFly\*, QuietCool, REM\*, RMS, RMsServer, SIM\*, SpaceMap\*, SpeakerSense, Stella, Thinking Sound\*, TM Array, TruPower\*, TruShaping\*, UltraSeries, U-Shaping\*, VariO, VRAS, Wild Tracks.

All third-party trademarks mentioned herein are the property of their respective trademark holders.

\*Registered in the United States Patent and Trademark Offices

---

# CONTENTS

<b>Chapter 1: Introduction</b>	<b>5</b>
How to Use This Manual	5
The Compass RMS Remote Monitoring System	5
Workflow for Compass RMS Configurations	7
<b>Chapter 2: Installing and Configuring RMServer</b>	<b>9</b>
About RMServer	9
RMServer Features and Functions	9
Installation and Mounting	10
Setting Up an RMS Network with RMServer	10
Connecting RMServer	10
Configuring the RMServer Web Server	12
<b>Chapter 3: Connecting RMS Networks</b>	<b>21</b>
Network Specifications	21
Twisted-Pair Cabling	21
Ethernet Hubs and Switches	22
Design Tips for RMS networks	23
Ethernet Configurations	24
<b>Chapter 4: HP/MP RMS Module</b>	<b>29</b>
Installing the HP/MP RMS Module	29
Installing the Mute Jumper on the HP/MP RMS Module	33
HP/MP RMS User Panel	34
Neuron ID for HP/MP RMS Modules	34
Resetting the HP/MP RMS Module	35
<b>Chapter 5: UltraSeries RMS Module</b>	<b>37</b>
Installing the UltraSeries RMS Module	37
Installing the Mute Jumper on the UltraSeries RMS Module	38
UltraSeries RMS User Panel	39
Neuron ID for UltraSeries RMS Modules	40
Resetting the UltraSeries RMS Module	40
<b>Chapter 6: DX RMS Module</b>	<b>41</b>
Installing the DX RMS Module	41
DX RMS User Panel	41
Neuron ID for DX RMS Modules	42
Resetting the DX RMS Module	42
<b>Chapter 7: MX RMS Module</b>	<b>43</b>
Installing the MX RMS Module	43
Installing the Mute Jumper on the MX RMS Module	45
MX RMS User Panel	46
Neuron ID for MX RMS Modules	46
Resetting the MX RMS Module	46

<b>Chapter 8: LYON RMS Module</b>	<b>49</b>
Installing the LYON RMS Module	49
Lyon RMS User Panel	50
Neuron ID for Lyon RMS Modules	51
Resetting the Lyon RMS Module	51
<b>Chapter 9: MPS-488HP External Power Supply with RMS</b>	<b>53</b>
MPS-488HP RMS User Panel	53
Neuron ID for MPS-488HP RMS Module	54
Resetting the MPS-488HP RMS Module	54
The MPS-488HP in Compass Software	54
<b>Appendix A: Comparison of RMS Modules</b>	<b>55</b>
<b>Appendix B: Troubleshooting RMS Problems</b>	<b>57</b>
<b>Appendix C: External Muting and External Warning Relays</b>	<b>61</b>
Wiring RMsServer for External Muting and External Warning Relays	62
Configuring External Muting in the RMsServer Web server	63
Configuring Warning Relays in the RMsServer Web Server	64
Email Notification for Externally Triggered Muting and Warning Relays	65
<b>Appendix D: FTR-120 Free Topology Repeater</b>	<b>67</b>
About the FTR-120	67
Installing and Using the FTR-120	67
<b>RMS Configuration Sheet</b>	<b>69</b>
	<b>70</b>



## CHAPTER 1: INTRODUCTION

This introductory chapter includes the following topics:

- “How to Use This Manual” on page 5
- “The Compass RMS Remote Monitoring System” on page 5
- “Workflow for Compass RMS Configurations” on page 7

### HOW TO USE THIS MANUAL

Make sure to read this user guide in its entirety before configuring a Compass RMS™ system. In particular, pay close attention to material related to safety issues.

As you read this user guide, you will encounter the following icons for notes, tips, and cautions:



**NOTE:** A note identifies an important or useful piece of information relating to the topic under discussion.



**TIP:** A tip offers a helpful tip relevant to the topic at hand.



**CAUTION:** A caution gives notice that an action may have serious consequences and could cause harm to equipment or personnel, or could cause delays or other problems.

[Default Values] are bracketed and are displayed in typewriter (monospace) font.

Information and specifications are subject to change. Updates and supplementary information are available at [www.meyersound.com](http://www.meyersound.com). Some places to check are:

- Compass RMS product page.
- RMS product page.
- Webinars and Product Tutorials areas of the Education page.
- Sound Support page.

Meyer Sound Technical Support is available at:

- **Tel:** +1 510 486.1166
- **Web:** [www.meyersound.com/support](http://www.meyersound.com/support)
- **Email:** [techsupport@meyersound.com](mailto:techsupport@meyersound.com)
- **After Hours Emergencies:** +1 510 486.0657

### THE COMPASS RMS REMOTE MONITORING SYSTEM



**NOTE:** In this manual, both RMS-equipped loudspeakers and MPS-488HP power supplies are generically referred to as "devices."

The Compass RMS remote monitoring system provides extensive real-time displays on a Windows or Mac OS X computer of status and performance data for each loudspeaker in a system, including amplifier voltage, limiting activity, power output, and fan and driver status. Soloing and muting of each loudspeaker is also available. Compass RMS consists of:

- **RMS module:** Each loudspeaker in an RMS network has an RMS module installed in it, which monitors parameters like limiting, fan speed, heat sink temperature, and amplifier power, and reports that information back to the Compass control software. The RMS module stores the type of loudspeaker in which it is installed, a loudspeaker ID, and a user-assigned name. Some Meyer Sound loudspeakers come standard with an RMS module installed while others offer it as an option. For more information, visit the Meyer Sound website.
- **RMServer:** Loudspeakers and other devices on an RMS network are connected to a computer running Compass software through RMServer hardware. Up to 50 loudspeakers or 12 MPS-488HP power supplies can be attached to each RMServer. RMServer replaces all iLON hardware used in legacy systems; iLON hardware is incompatible with Compass-based RMS networks.
- **Compass control software:** Provides an integrated environment for controlling and monitoring loudspeaker systems. Compass uses a graphical user interface running on a remote computer to display information provided by the Compass RMS remote monitoring system, and provide comprehensive control of CAL column array loudspeakers, Galileo loudspeaker management processors, and Callisto array processors.

Compass software includes a context-sensitive help system, and full copy and paste of all settings and groups of settings. The tabbed interface can be scaled to any display resolution and the color scheme or contrast can be configured for either day or night. Windows and Mac OS X versions have the same user interface, so switching between platforms is completely transparent.

**TIP:** For information on installing and using Compass control software, see the *Quick Start Guide* on the Compass RMS product page at [www.meyersound.com](http://www.meyersound.com).

Compass RMS incorporates an established network platform developed by Echelon Corporation, the world’s leading supplier of networking technology for sensing, monitoring, and control. The networking platform supports Free Topology, is polarity insensitive, does not require coaxial or fiber optic cabling, and is not affected by power losses at loudspeaker nodes. An RMS network is a real-time data acquisition system, which means that no data is lost during transmission.

Once loudspeakers are identified on the RMS network, they appear in the Compass software as icons or meter views with pop-up text displays; they are automatically added to the RMServer inventory and Compass Project.

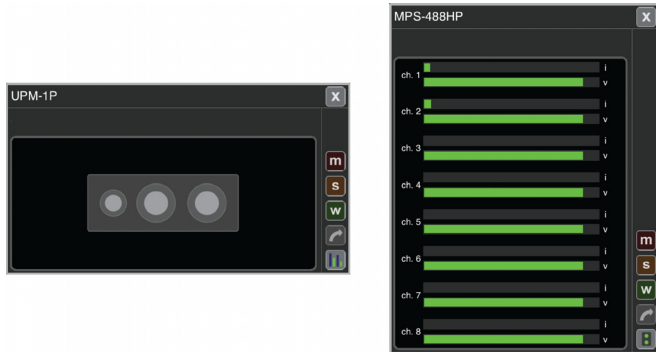

Figure 1: Some RMS objects as they appear on user pages.

Compass displays all loudspeakers on the network on user-created pages under the RMS tab. Pages display icons and meter views that you customize to suit your needs. Loudspeaker icons and meter views can be arranged to represent how the loudspeakers have been deployed in the system. Multiple pages can be created for specific system configurations and venues, saved as an RMS Project, and reloaded as needed.

Loudspeaker data is updated 2-5 times per second. Individual loudspeakers can be physically identified with the Wink option in Compass, which lights the Wink LED on the RMS module for that particular loudspeaker. Conversely, a device can be identified in Compass by pressing the Identity or Service button on the device’s RMS module.



Figure 2: A user-created page under the RMS tab in Compass.

### Compass RMS Software System Requirements

Compass RMS software runs as a tab within the Compass software environment. Compass requires a computer running Windows® or Mac OS X. Please visit [www.meyersound.com](http://www.meyersound.com) for the latest compatibility information and more information about Compass.

### Additional Networking Hardware Requirements

Depending on the number of loudspeakers in the RMS network, as well as the length of cabling used, additional networking hardware — such as repeaters, terminators, switches, or hubs — may be required. In some cases, multiple RMServers may be recommended. For more information, see Chapter 3, “Connecting RMS Networks.”

## WORKFLOW FOR COMPASS RMS CONFIGURATIONS

To configure a Compass RMS system, use the following steps:

1. Prepare any retrofitted or legacy equipment for integration into a Compass RMS system. For more information, see the next section, “Upgrading, Retrofitting, and Legacy Loudspeakers” on page 7
2. Install RMServer as described in the section “Installation and Mounting” on page 10
3. Attach RMServer to the computer’s Ethernet port or to a network router or network switch as described in the section “Remote Computer Connection” on page 10
4. Connect RMServer to your RMS-equipped devices as described in the sections “Connecting RMServer to Your RMS-Equipped Loudspeakers” and “Connecting RMServer to the MPS-488HP” on page 11
5. Configure network settings on RMServer and your computer. as described in the section “Configuring the RMServer Web Server” on page 12
6. Install the Compass control software. For more information, see the *Quick Start Guide* on the Compass RMS product page at [www.meyersound.com](http://www.meyersound.com).
7. Launch and configure the Compass control software. For more information, see the *Quick Start Guide* on the Compass RMS product page at [www.meyersound.com](http://www.meyersound.com).

### Upgrading, Retrofitting, and Legacy Loudspeakers

Additional steps in setting up a Compass RMS system are required if:

- You are transitioning from a legacy iLON-based RMS system.
- You are retrofitting any Meyer Sound loudspeakers with RMS modules.
- You are using Meyer Sound loudspeakers that contain RMS modules but were built prior to June 2012. This usually will be the case if you are transitioning from an iLON-based RMS system.

It is always the case in these last two situations, and usually the case when transitioning from an iLON-based system, that each loudspeaker must be manually initialized with its loudspeaker ID information. Loudspeakers built after June 2012 with RMS modules installed are initialized at the factory.

To facilitate manual initialization, be sure to make a list of the models and Neuron IDs of all loudspeakers other than those built after June 2012. The Neuron ID is displayed on each loudspeaker’s RMS user panel. You can use the datasheet on page 69 of this user guide for creating a list of loudspeakers in the setup. For more information see the section “Setting IDs for legacy RMS cards” in the *Quick Start Guide* available on the Compass RMS product page at [www.meyersound.com](http://www.meyersound.com).

### Transitioning from a Legacy iLON System

Upgrading from a legacy, iLON-based system to a Compass-based RMS network is not difficult. The main difference, of course, is the substitution of RMServer units for iLON 10 Ethernet adapters and iLON 600 servers. However, there are a few important things to note:

- You MUST disconnect the host station hardware and remove it entirely from the network; it is incompatible with Compass RMS. This includes removing U10 USB connectors, iLON 10 Ethernet adapters, and iLON 600 servers.
- In distributed systems and some other situations, a legacy iLON system may have been configured with small groups of loudspeakers attached to individual iLON hardware units. Smaller groups can be consolidated in a Compass RMS system, up to RMServer’s maximum of 50 loudspeaker nodes.
- Reverting back to an iLON-based RMS system after upgrading to a Compass-based RMS network is not recommended, but it is possible to do simply by restoring the iLON hardware in place of RMServer, and using the old RMS software instead of Compass. However, doing this is likely to require rediscovering the entire system.



**NOTE:** Some products are not supported by legacy RMS software and iLON-based systems.

### Retrofitting Loudspeakers with RMS Modules

Information on installing RMS modules into Meyer Sound loudspeakers that did not come with them can be found elsewhere in this manual:

- For loudspeakers requiring an HP/MP RMS module, see “Installing the HP/MP RMS Module” on page 29. To enable mute and solo capabilities in these loudspeakers, see “Installing the Mute Jumper on the HP/MP RMS Module” on page 33.

- For loudspeakers requiring an UltraSeries RMS module, see “Installing the UltraSeries RMS Module” on page 37. To enable mute and solo capabilities in these loudspeakers, see “Installing the Mute Jumper on the UltraSeries RMS Module” on page 38.
- For loudspeakers requiring a DX RMS module, see “Installing the DX RMS Module” on page 41. To enable mute and solo capabilities in these loudspeakers, see “Remote Mute Switch” on page 42

## CHAPTER 2: INSTALLING AND CONFIGURING RMSERVER

### ABOUT RMSERVER

RMServer is the central hardware component of a Compass RMS remote monitoring system. RMServer is a compact server that connects up to 50 RMS-equipped loudspeakers or 12 MPS-488HP power supplies to a computer running Compass control software. (Each MPS-488HP can drive up to eight loudspeakers for a total of 96 loudspeakers on a single RMServer.)

### RMSERVER FEATURES AND FUNCTIONS

#### RMServer Front Panel

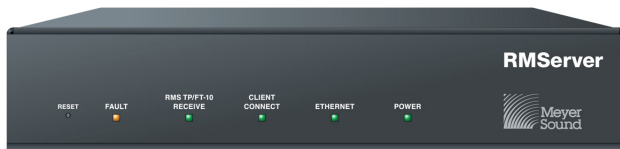

Figure 1: The RMServer front panel

The RMServer front panel contains a Reset button and a number of indicators.

**Reset button:** Pressing the Reset button restarts RMServer. There are several reset modes invoked by different kinds of button presses. For more information on restarting RMServer, see the section “Restarting RMServer” on page 18.

**Fault indicator:** Indicates loudspeaker faults and abnormal operating conditions. The Fault indicator is also used to show when RMServer is running in failsafe mode. For more information on when to use failsafe mode see the section “RMServer Failsafe (Recovery) Mode” on page 18.

**RMS TP/FT10 Receive LED:** Indicates that RMServer is receiving messages from a device.

**Client Connect LED:** Indicates that RMServer is failsafe-connected to a client computer running Compass control software.

**Ethernet LED:** Indicates Ethernet activity when RMServer is connected to a computer running Compass control software.

**AC Power LED:** Indicates when RMServer is receiving AC power.

#### RMServer Rear Panel

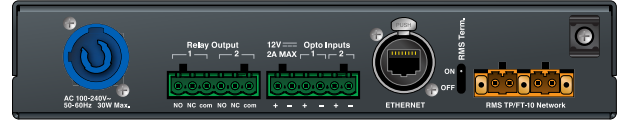

Figure 2: The RMServer rear panel.

**PowerCon AC Power Connector:** This locking connector mates with the provided AC power cable.

**CAUTION:** Make sure the AC power cable has the appropriate power plug (on the other end) for the area in which you will operate RMServer.

**NOTE:** RMServer incorporates Meyer Sound’s Intelligent AC power supply, which automatically adjusts for any line voltage between 90 and 264 volts, and provides both soft turn-on and transient protection.

**Relay Outputs:** Alert conditions can be signaled to external devices by changing the state of two onboard relays.

**+12V Output:** Provides voltage for outboard contact closure relays connected to RMServer’s opto-isolated inputs, such as those used in fire alarm or other emergency systems to trigger loudspeaker muting.

**TIP:** For more information about connecting relays to RMServer’s inputs, see the section “Connecting RMServer” on page 10.

**Opto-Inputs 1 and 2:** For installations where RMServer is part of a fire alarm or evacuation system, the active audio inputs (main program sources) of all devices connected to that RMServer can be muted using these opto-isolated inputs. The mute can be triggered with a relay closure attached to the Opto Input pins. Each pin is triggered when it receives a voltage 3 to 20 VDC greater than its associated COM pin. The source of this voltage is commonly the +12 V output. When triggered, the isolated opto input instructs RMServer to mute all Mute Enabled connected loudspeakers.

**CAUTION:** Do not send voltages greater than 20 V DC to the Logic I/O pins as this may damage the input circuitry.



**NOTE:** The logic I/O connectors (Relay outputs, +12 V, Inputs 1 and 2) are optically isolated from the RMServer circuitry. In addition, each COM pin is isolated to allow for the use of appropriate reference voltages for each associated logic function. A logic function is triggered when the + pin on the connector receives a voltage 3 to 20 V DC greater than its associated COM voltage.

**Ethernet Connector:** RJ-45 connector for connecting RMServer to an Ethernet network, so it can be controlled from a computer running Compass control software. Use a shielded CAT-5e cable (recommended) or high-quality Ethernet data cable.

**RMS termination switch:** RMServer is capable of providing standard 52.3 ohm network termination.

- To engage network termination on RMServer, use a paper clip, screwdriver, or similar small implement to flip the RMS Term switch to the On position.

**RMS TP/FT10 Network connectors:** The two Weidmuller connectors transfer data to and from the RMS network. Two connectors are provided to allow for easy connection of multiple daisy-chained loudspeakers on the network. RMS cable connectors and mounting blocks for constructing RMS cables are included with each RMS-equipped loudspeaker. The RMS blocks allow the cables to be securely attached to the RMS module with screws.

**RMServer MAC address:** The ID displayed on the bar-coded sticker on the rear panel is the MAC address of the RMServer unit, which is displayed on the Network page of the RMS tab in Compass software. (A MAC, or Media Access Control, address is a unique identifier for a network interface.)

## INSTALLATION AND MOUNTING

Rackmount (Meyer Sound Part Number: 40.222.015.01) and wallmount (Meyer Sound Part Number: 04.222.014.01) kits are available for RMServer. Two RMServers can be installed in one rackmount shelf.

For more information on mounting kits for RMServer, contact Meyer Sound.

An integral tie-wrap anchor (width: 0.176 in/4.47 mm) on the rear panel enables strain relief for power and signal cables attached to RMServer. Insert a plastic tie-wrap through the anchor and wrap it around the cables.

## SETTING UP AN RMS NETWORK WITH RMSERVER

To connect RMServer into your system and set up an RMS network:

1. Attach RMServer to the computer's Ethernet port or to a network router or network switch.
2. Connect RMServer to your RMS-equipped devices.
3. Configure network settings on RMServer and your computer. For more information see the section "Configuring the RMServer Web Server" on page 12.
4. Install the Compass control software.
5. Launch and configure the Compass control software.

## CONNECTING RMSERVER

### Power Connector

RMServer uses a locking PowerCon® connector to provide AC voltage to the unit. Its internal switching power supply accepts voltages from 90 to 264 V AC, 50/60 Hz.



**CAUTION:** Electrical Safety Issues! Pay close attention to these important electrical and safety issues:

- Make sure the AC power cable has the appropriate power plug (on the other end) for the area in which you will operate RMServer.
- Always use a grounded outlet and plug.



**CAUTION:** To comply with EMC standards, only operate this device with the supplied shielded power cord.

### Remote Computer Connection

RMServer's RJ-45 port connects to a standard Ethernet port with a shielded Cat-5e or Cat-6 cable. The Ethernet connection allows the unit to be controlled remotely from a Mac or Windows computer running Compass control software. RMServer can operate on the same network as Galileo processors and other Meyer Sound network devices.



## IPv4, IPv6, and RMServer

The internet is currently near the beginning of a migration from the IPv4 protocol it has used for years to the newer IPv6 protocol. IPv4 uses a 32-bit address for each machine, and unique addresses are running out. IPv6 uses 128-bit addresses, commonly incorporating each computer's fixed Media Access Control (MAC) address.

This will be a long, slow transitional period, in which it will be common for all systems employing IP to contain a mix of systems capable of IPv4, IPv6, or both. Currently, it is easier to use IPv6 in Mac OSX than in Windows, though Windows is technically capable of it.

 **TIP:** The settings in the Host and Network Information section of RMServer web server's Basic Settings tab pertain only to the use of IPv4. However, for the most reliable flexibility in operation, Meyer Sound recommends filling out all of the fields in the Host and Network Information section, even if you do not anticipate your network will need to use IPv4. For more information on the Host and Network Information section, see the section "Configuring the RMServer Web Server" on page 12.

 **NOTE:** RMServer ships from the factory set to a default static IPv4 address. In order to change the IPv4 address, it is necessary to access RMServer's web server page. For more information on setting RMServer's IPv4 address, see the section "Accessing the RMServer Web Server" on page 12. The Bonjour and host name methods listed there eliminate the use of IPv4.

## Connecting RMServer directly to your computer

If you are using only a single RMServer unit and no Galileo or other Meyer Sound device, you can connect it directly to your computer's Ethernet port. This is the simplest possible connection. If you are using IPv4, your computer and RMServer must be set to the same IPv4 network range to communicate.

## Connecting RMServer to a network switch

Larger systems requiring more than one RMServer or that include Galileo processors or other Meyer Sound devices will connect to your computer through a network switch.

 **NOTE:** When connecting an RMServer to a computer through a router, make sure the router is appropriately configured.

## Connecting RMServer to Your RMS-Equipped Loudspeakers

RMServer connects to RMS-equipped loudspeakers through 20 AWG twisted pair, stranded, unshielded cable (Belden 8205 or equivalent). To reduce the amount of twisted-pair cabling in an RMS network, groups of neighboring loudspeakers can be daisy-chained.

For twisted-pair cabling, the following limitations apply:

- Maximum number of RMS nodes: 50
- Maximum number of MPS-488HP power supplies: 12
- Maximum length of total cabling: 1640 ft (500 m). An FTR-120 repeater can be used for cable runs longer than 500 m.

RMS-equipped loudspeakers and MPS-488HP power supplies can be mixed on a single RMServer (which has two paralleled network connectors), as long as the total number of loudspeakers does not exceed 50. Note that each MPS-488HP counts as four loudspeakers for this purpose, even though the power supply can drive up to eight loudspeakers. For example, you could connect five MPS-488HP units (counting as 20 loudspeakers) and 30 RMS-equipped loudspeakers to a single RMServer.

 **TIP:** For more information on connecting loudspeakers in an RMS network, see Chapter 3, "Connecting RMS Networks".

## Connecting RMServer to the MPS-488HP



Figure 3: The rear panel of an MPS-488HP power supply includes the same Weidmuller connectors found on RMS modules in loudspeakers.

RMServer is connected to an MPS-488HP power supply in the same fashion as it is connected to RMS-equipped loudspeakers, via the Weidmuller connectors on the MPS-488HP. Loudspeakers connected to an MPS-488HP differ from Meyer Sound self-powered loudspeakers in that they are powered by 48 VDC from the MPS-488HP, rather than receiving AC power directly. Also, as mentioned above, for the purposes of the loudspeaker inventory count, each MPS-488HP must be counted as four loudspeakers.



**TIP:** For more information on integrating an MPS-488HP into an RMS network, see Chapter 3, “Connecting RMS Networks”.

## RMServer Inventory

Under the control of Compass control software RMServer compiles an inventory of all devices connected. In addition to being displayed in Compass, this inventory is automatically saved in non-volatile memory onboard the RMServer and loaded by default each time RMServer is powered up.

The inventory is retained unchanged until modified by the user from within Compass.

## Connecting Relays

In many sound systems it is necessary to have the ability to mute all loudspeakers in an emergency or failure condition. This function is usually triggered by a simple relay action. RMServer's two inputs accommodate triggering of loudspeaker muting from external relays. Triggering of external systems is supported by two onboard relays that fire under conditions set in RMServer's web server pages. RMServer's onboard relays can be wired to operate either as Normally Open (NO) or Normally Closed (NC).

For more information on wiring and configuring RMServer for use with fire alarm muting systems, see Appendix C, “External Muting and External Warning Relays”

## CONFIGURING THE RMSERVER WEB SERVER

### Accessing the RMServer Web Server

The RMServer web server can be accessed in two different ways: from Compass or using a browser.

The default user name and password for login are both “admin”.

RMServer can be accessed from Compass if it has already been configured, has already been found by Compass, and is displayed in the device list on the Network page:

- Right-click on the device name of the server in the list and choose Access Web Server from the menu that drops down to open the web server login window.

The other way to access the web server is using a standard browser. Meyer Sound recommends using Google Chrome, Mozilla Firefox, or Apple Safari to communicate with RMServer. There are three methods for accessing the web server from a browser:

### As a Bonjour Client (Safari only)

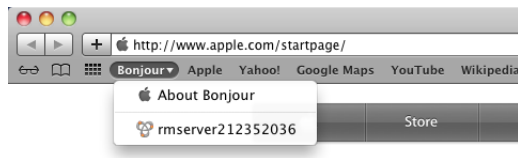

Figure 4: In Safari running in Mac OS X, Bonjour provides an easy method of communicating to RMServer using IPv6.

Apple's Bonjour protocol supports IPv6 in Mac OS X, but only IPv4 in Windows.

1. In Safari, open Safari Preferences and go to the Bookmarks tab.
2. In the Bookmarks bar section, click the Include Bonjour check box to select it. Close the Preferences dialog.
3. Click on the Bonjour link on the left of the Bookmarks bar. A menu will drop down.
4. Choose RMServer from the menu. It is identified in the list with its host name and device name. The login page will appear.

### Using RMServer's Host Name

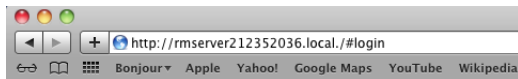

Figure 5: RMServer can be reached from any browser by using its host name.

Communication with RMServer by its host name is accomplished using IPv6.

1. Open a browser.
2. In the URL address line, enter: `rmserver<serial number>.local`, where <serial number> is the serial number of the RMServer unit, found on a sticker on the rear panel,

for example: <http://rmserver213020341.local>. The web server login page will appear.

### Using RMServer's IPv4 Address

Meyer Sound recommends accessing RMServer using IPv6 whenever possible, however, users with Windows machines or legacy equipment may need to continue using IPv4 to access RMServer. The default IPv4 address of RMServer is 192.168.0.120.

1. If your network is already set to the 192.168.0.x network range, you should skip step 3.



2. Connect your computer's Ethernet directly to RMServer.
3. Set your computer to a static IP address in the network range 192.168.0.x.
4. Open your browser and point it to 192.168.0.120, the default address of RMServer. The login page will appear.
4. In the Network Information area, change the Static IP Address field to an address with the network range you want to use.
5. Enter the proper Subnet Mask and Gateway settings. The default subnet mask is 255.255.255.0, the default gateway address is 192.168.0.1.
6. Click the Save Settings button at the bottom of the window.
7. A dialog will appear saying that restart is required. Click the Restart Now button to restart RMServer.
8. Change your computer (and router, if present) IP address to the same network range as RMServer.
9. Test the connection by pinging RMServer with the ping command in a terminal.



**TIP:** If any of these methods appears to hang up, try clicking in the URL address bar of the browser and pressing Enter to reapply the URL request.

## Setting an IPv4 Address for RMServer

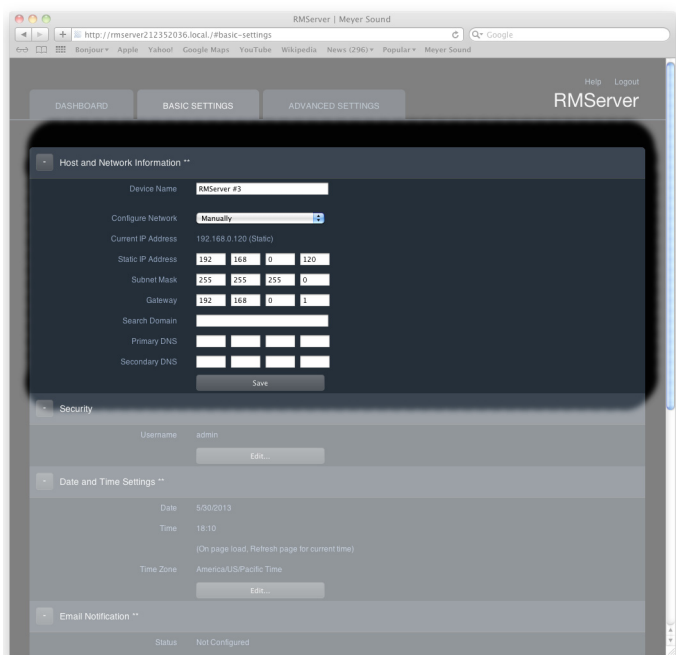

Figure 6: The Host and Network Information area of the Basic Settings tab holds IPv4 settings.

In order for users employing IPv4 to communicate with RMServer, the computer, router, and RMServer all need to be set to the same IP network range. To set RMServer's IPv4 address:

1. Login to RMServer's web server page.
2. Go to the Basic Settings tab.
3. In the Network Information area, confirm that the Configure field is set to Manually.

## Settings

The Dashboard tab displays current settings. Settings are adjusted in the Basic and Advanced Settings tabs.

Settings groups on the Basic and Advanced Settings pages can be expanded or collapsed by clicking on the disclosure triangle to the left of the settings group name.

## Dashboard

The Dashboard tab displays setup parameters for RMServer, but editing of parameters is done on the Basic and Advanced Settings pages.

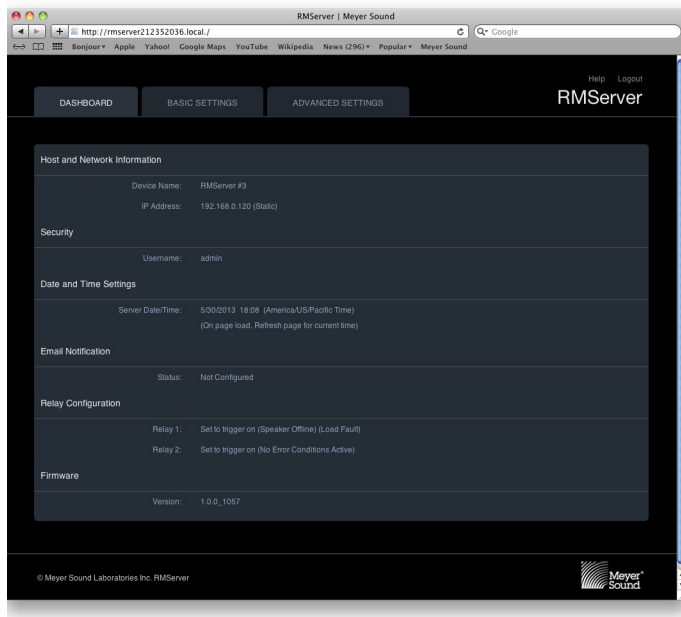

Figure 7: The Dashboard in RMsERvER's web server displays essential setup parameters for RMsERvER.

**Host and Network Information:**

Device Name: The name assigned by the user to the RMsERvER unit.

[RMsERvER #n]

IP Address: IPv4 address of RMsERvER.

[192.168.0.120 (Static)]

**Security**

Username: The user account name. Default is admin.

**Date and Time Settings**

Server Date Time: The server date and time are used in RMsERvER's logging and for timestamping email alerts, and are usually set to the current date and time.

**Email Notification**

Displays email alerts that have been enabled by the user.

[Not Configured]

**Relay Configuration**

Displays the fault conditions that trigger RMsERvER to change the state of the indicated relay output.

[Relay 1: Set to trigger on (Speaker Offline) (Load Fault)]

[Relay 2: Set to trigger on (Speaker Offline) (Load Fault)]

**Firmware**

Displays the firmware version currently running in RMsERvER.

**Basic Settings**

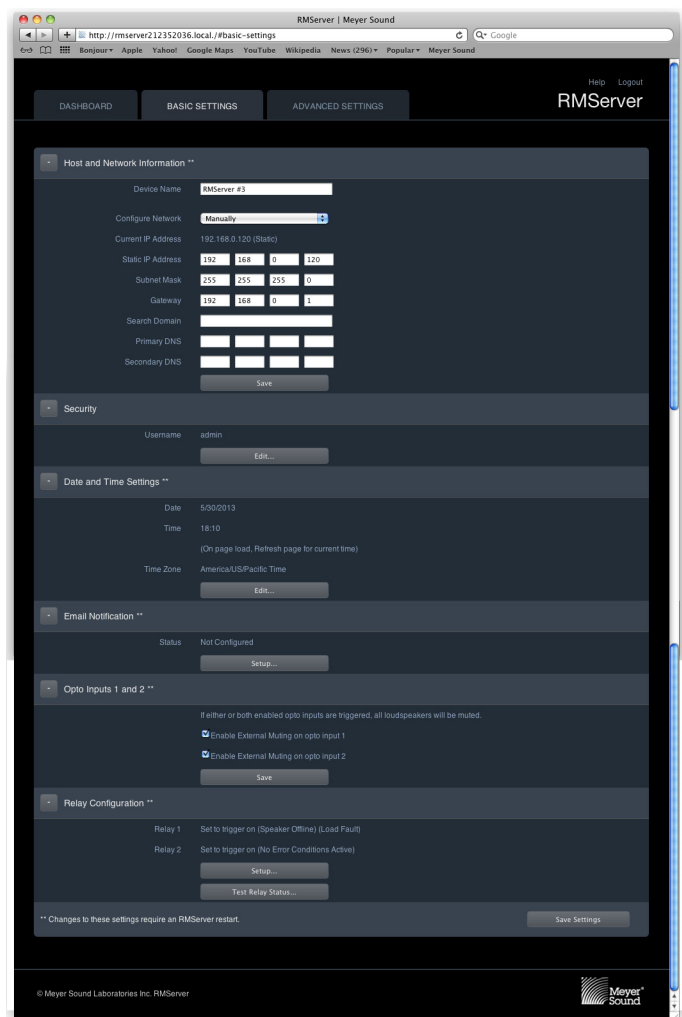

Figure 8: The Basic Settings page of RMsERvER's web server.

**NOTE:** Changes to settings in this section that are marked with a double asterisk (\*\*) take effect after RMServer has been restarted.

### **Host Information and Network Information\*\*:**

**Device Name:** The name that will appear for RMServer in the Network page of the RMS tab of Compass.

[RMServer #n]

**Configure:** Choose Manually or Using DHCP from the drop-down menu. Designates whether the IPv4 address of RMServer is specified or assigned using DHCP.

**Current IP address:** The IPv4 address currently assigned to the RMServer unit.

[192.168.0.120 (Static)]

**Static IP Address:** The IP v4 address used when Configure is set to Manually.

[192.168.0.120]

**Subnet Mask:** The IPv4 subnet address.

[255.255.255.0]

**Gateway:** The IPv4 address of a router in the network.

[192.168.0.1]

**Search Domain:** A search domain is a kind of shortcut DNS filtering method to simplify reaching sites you visit often. Once specified by the user, a search domain is automatically appended to typed text in the URL address bar of a browser. Enter the desired search domain in this field.

**Primary DNS:** DNS settings are used only when the mail server specified for email alerts uses IPv4 protocol, and the user wishes to address it by name, instead of by its IPv4 address. In other circumstances, DNS settings are not needed.

[192.168.50.11]

**Secondary DNS:** Part of the DNS settings required to address a mail server using IPv4 protocol by name.

[192.168.50.12]

### **Security**

**Username:** Displays the current user name.

**Edit button:** Opens Security Settings dialog for editing the user name or password.

### **Security Settings dialog:**

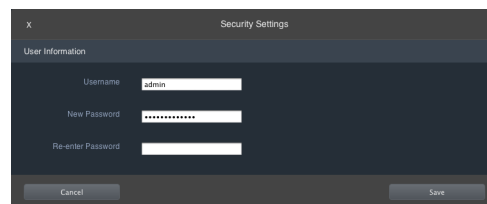

Figure 9: The user name and password are edited in the Security Settings dialog.

**Username:** Enter the user name you want. Any ASCII characters can be used. User names are case sensitive.

**Password:** Enter the password you want. Any ASCII characters can be used. Only the first eight characters of a password are used for verification. Passwords are case sensitive.

**Reenter Password:** Reenter the password you want.

Click the Save button in the lower right to save the settings. The Cancel button in the lower left exits the dialog without saving changes. A close box for the dialog is in the upper left corner.

### **Date and Time Settings**

This section displays current date, time, and time zone settings. To change these settings, click the Edit button to open the Date and Time Settings dialog.

**Date:** Displays the date on the server clock, which can be set by the user to a convenient date and time, usually the current date and time. The server clock is used by RMServer when making log entries and timestamping email alerts.

[Date of manufacture]

**Time:** Displays the current time in hours and minutes, using a 24-hour format (00:00 to 23:59). This field is set on page load. Refresh the page to update this field to the current time.

**Time Zone:** Displays the current time zone setting.

[America/US/Pacific Time]

**Edit button:** Opens the Date and Time Settings dialog, where the date, time, and time zone settings can be edited.

## Date and Time Settings Dialog

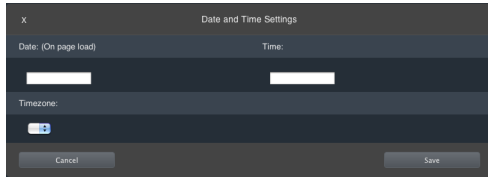

Figure 10: Date, time, and time zone are set in the Date and Time Settings dialog.

**Date:** To change the date, click in the field and use the calendar that drops down to set the date.

**Time:** To change the time, click in the field and choose the desired time from the list that drops down.

**Time Zone:** To change the time zone, click in the field and choose your time zone from the list that drops down.

Click the Save button in the lower right to save the settings. The Cancel button in the lower left exits the dialog without saving changes. A close box for the dialog is in the upper left corner.

## Email Notification\*\*

Status:

(Not Configured)

**Setup button:** Click to open the Edit Email Configuration dialog.

### Edit Email Notification Dialog\*\*

**Send To:** Enter the email address to which you want email alerts sent. Multiple email addresses can be entered, separated by commas.

**Events (checkboxes):** These checkboxes indicate the events whose occurrence triggers an email alert.

When external muting is triggered

When external relays are triggered

**Intervals:** Limits the frequency with which alarm signals are sent.

**Alarms no more than once per every (drop down w/times 15 s – 24 h)**

**SMTP Configuration:** In order to send email notifications, RMServer must be configured to communicate with an SMTP server than can send mail. These are the same parameters required to set up an email client on your computer, though the values you enter here may or may not be the same as for your personal email.

**SMTP Server:** The URL of the outgoing mail server.

**Port:** [33]

The section of three security settings is enabled by the checkbox at its top.

**SMTP Server Requires Authentication checkbox:** Enables security settings.

**Encryption Type:** To set the encryption type, click in the field and choose the desired encryption from the menu that drops down.

**Username:** Enter the username on the account you are logging into.

**Password:** Enter the username on the account you are logging into.

The Send Test Email button at the bottom of the dialog sends a message to the email address specified in the Send To: field, so that successful address of the email path is confirmed.

Click the Save button in the lower right to save the settings. The Cancel button in the lower left exits the dialog without saving changes. A close box for the dialog is in the upper left corner.



**TIP:** For more information on using the Opto Inputs and Relay Outputs, see Appendix C, “External Muting and External Warning Relays.”

## Opto Inputs 1 and 2\*\*

If either or both enabled opto inputs are triggered, all loudspeakers with mute jumpers configured will be muted.

Checkboxes:

Enable External Muting on opto input 1

Enable External Muting on opto input 2

The Save button applies any changes made in this section and saves the settings to RMServer.

## Relay Configuration\*\*

Relay 1 Displays current settings for relay 1.

(Set to trigger on (Speaker Offline) (Load Fault))

Relay 2 Displays current settings for relay 1.

(Set to trigger on (Speaker Offline) (Load Fault))

**Setup button:** Opens the Edit Relay Setup dialog, where relay behavior is specified.

Test Relay Status button: Opens the Test Relay Status dialog.

### Edit Relay Setup Dialog\*\*

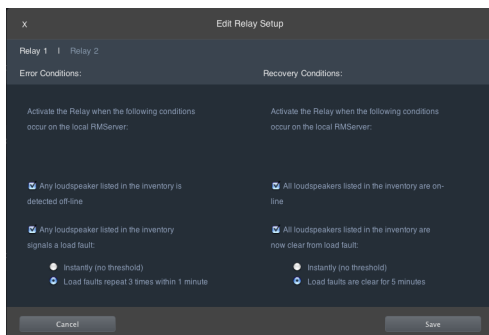

Figure 11: Relay behavior is defined in the Edit Relay Setup dialog.

Relay 1/Relay 2: Click one of these legends at the top of the dialog to edit settings for the selected relay.

#### Error Conditions

This section provides check boxes for the error conditions that will trigger a state change of the relay being edited. The relay will change state if either of the specified conditions occurs.

Any loudspeaker listed in the inventory is detected off-line.

Any loudspeaker listed in the inventory signals a load fault: For this condition, one of the associated radio buttons must be chosen.

Instantly (no threshold)

Load faults repeat 3 times within 1 minute.

#### Recovery Conditions

This section provides check boxes for the conditions indicating restoration of normal operation that will trigger a state change of the relay being edited. The relay will change state if either of the specified conditions occurs.

All loudspeakers listed in the inventory are on-line

All loudspeakers listed in the inventory are now clear from load fault: For this condition, one of the associated radio buttons must be chosen.

Instantly (no threshold)

Load faults are clear for 5 minutes.

Click the Save button in the lower right to save the settings. The Cancel button in the lower left exits the dialog without saving changes. A close box for the dialog is in the upper left corner.

### Test Relay Status Dialog

Displays the current status of Relay 1 and Relay 2. The button next to each line changes the state of the indicated relay.

Click the Done button or the close box at the top left to close the dialog and save the settings.

**NOTE:** Relays remain in the state indicated in the Test Relay Setup dialog after it is closed. They are not reset to the value they were in when the dialog was opened.

### Advanced Settings

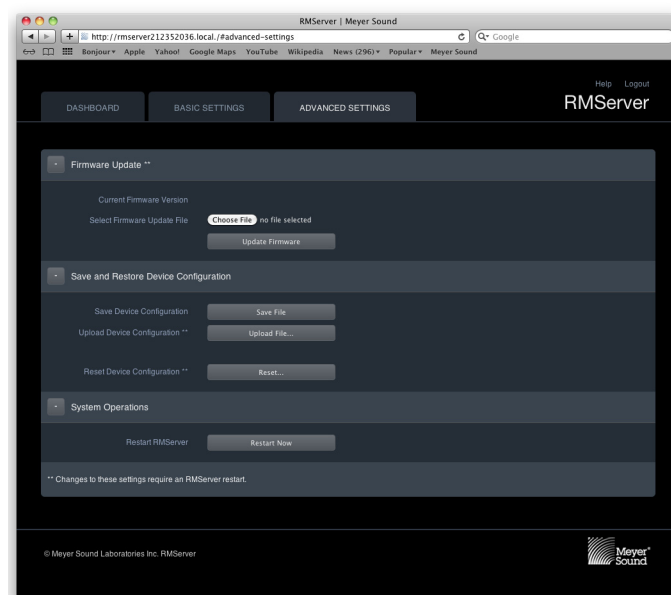

Figure 12: The Advanced Settings page of RMServer's web server.

**NOTE:** Changes to settings in this section that are marked with a double asterisk (\*\*) take effect after RMServer has been restarted.

#### Firmware Update\*\*

Current Firmware Version: Displays currently installed firmware version.

Select Firmware Update File: The Choose File button opens a file browser for navigating to and selecting firmware update files. When a file is selected, its name is displayed next to the button.

Update Firmware button: Clicking this button begins execution of the firmware update process using the selected file shown above.

For a complete firmware update procedure, see the section “Updating RMsServer’s Firmware” on page 18.

### Save and Restore Device Configuration

A device configuration file contains all of the settings from the Basic Settings and Advanced Settings pages of the RMsServer web server page.

**Save Device Configuration:** Clicking the Save File button saves the current device configuration to a file in your computer’s default user Downloads folder.

**Upload Device Configuration\*\*:** Clicking the Upload File button opens a file browser. Navigate to and select the Device Configuration file you wish to upload to RMsServer.

**Reset Device Configuration\*\*:** Clicking the Reset button restores factory default values for RMsServer.

### System Operations

**Restart RMsServer:** Clicking the Restart Now restarts RMsServer, which reloads settings. Click this button after making changes to sections marked with a double asterisk (\*\*\*) to make the changes take effect.

## Updating RMsServer's Firmware

1. Login to the RMsServer web server.
2. Access the Advanced Settings tab of the RMsServer web server.
3. Click the Choose File button in the Firmware Update section to open a file browser.
4. Navigate to the firmware update file and click OK to close the dialog.
5. Click the Update Firmware button to start the firmware updating process.
6. When the updating process completes, restart RMsServer by clicking the Restart Now button in the dialog that appears.

## Restarting RMsServer

There are four ways to restart RMsServer. The front panel Reset button is recessed, so a paper clip or similarly small implement is required to press it.

1. Press the Reset button on the front panel once to restart RMsServer and reload the current settings.

2. Click the Restart Now button in the System Operations section of the Advanced Settings tab of RMsServer’s web server to restart RMsServer and reload the current settings.
3. Hold the Reset button on the front panel down for five seconds while RMsServer is running to restart RMsServer and restore the factory default settings.
4. Holding the Reset button on the front panel while powering on RMsServer will restart the unit in failsafe mode. Continue holding the Reset button until the Fault LED remains solid.

When the power LED stays on solid, restart is complete. In failsafe mode, the power LED flashes slowly.

**NOTE:** In the initial release of RMsServer (with Compass 3.0.0), if you are using Bonjour to communicate with RMsServer, the web server login page will not be automatically displayed when restarting is complete. However, the login page is easily accessed using any of the regular methods.

## RMsServer Failsafe (Recovery) Mode

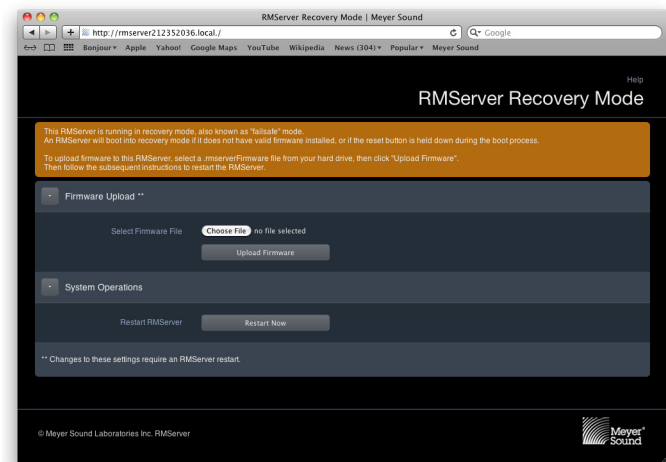

Figure 13: The failsafe mode web server page is simpler than the normal RMsServer web server page.

Failsafe mode (also called “recovery” mode) should be invoked only in cases of serious RMsServer problems, such as a failed firmware update or an inability of RMsServer to boot properly.

If the unit does not boot, enter failsafe mode as described above and then point your browser to the web server page. The failsafe web server page is much simpler than the regular web server page, allowing only firmware updates (along with updating instructions).

If RMServer cannot load the most recent firmware when it boots up, it will try the previous version that was installed. If neither one works, it will boot into failsafe mode on its own.





## CHAPTER 3: CONNECTING RMS NETWORKS

This chapter documents connecting RMS networks and includes the following topics:

- “Network Specifications” on page 21
- “Twisted-Pair Cabling” on page 21
- “Ethernet Hubs and Switches” on page 22
- “Design Tips for RMS networks” on page 23
- “Ethernet Configurations” on page 24

### NETWORK SPECIFICATIONS

#### Maximum Loudspeaker Nodes

- 50 for each RMsServer

 **NOTE:** Each MPS-488HP power supply occupies the bandwidth of four normal loudspeakers (four nodes). Bandwidth restrictions dictate that a maximum of 12 MPS-488HPs can be connected to a single network interface or RMsServer

 **NOTE:** The SB-3F loudspeaker occupies the bandwidth of two normal loudspeakers. Therefore, a maximum of 25 SB-3F loudspeakers can be connected to single network interface or RMsServer

#### Cable Type

- Twisted-pair: 20 AWG (Belden 8205 or equivalent) twisted pair, stranded, unshielded
- Low-voltage; Multi-conductor multimedia control cable (Belden 1502R or equivalent)
- Ethernet: Category 5 (Cat 5) or higher specification

 **NOTE:** The maximum length for Ethernet cables is 328 ft (100 m). When connecting RMsServer to an Ethernet hub or switch, use a straight-through (patch) cable. When connecting directly to a computer Ethernet port, use a crossover cable.

#### Connector Type

- Twisted pair: Weidmuller 2-conductor locking connector
- Ethernet: 10BASE-T, type RJ-45
- Portable: XLR and EN3

#### Maximum Network Length (without Repeaters)

- Free topology: 500 m (1,640 ft) with 20 AWG, 18 AWG or 16 AWG cable and one 52.3-ohm type terminator
- Ethernet: 10BASE-T network limitations plus standard twisted pair limitations
- Twisted-pair cabling: Total length per network segment should not exceed 1640 ft (500 m). For systems with network repeaters, the distance to the first loudspeaker also should not exceed 1640 ft (500 m).

 **NOTE:** For optimum performance, the twisted-pair cabling between RMsServer and first loudspeaker should not exceed 1,450 ft (450 m).

#### Termination

- Free topology: One 52.3-ohm type terminator at any point

#### Network Platform

- Differential Manchester encoding; polarity insensitive, free topology

#### Transceiver

- EMI, complies with FCC Part 15, Class A; UL recognized; VDE, EMI compliant

#### Data Rate

- 200 ms transfer rate with 20 loudspeakers

 **CAUTION:** Compass RMS software and hardware components interact continuously, communicating information about the connected loudspeakers to the host computer. If the network is overloaded, critical data may reach the host computer very slowly, or not at all. Meyer Sound recommends that Ethernet-based RMS configurations be deployed as a closed network, to reduce congestion from outside network activity. All Galileo units in the system should be on this network.

### TWISTED-PAIR CABLING

The Weidmuller Network connectors on RMS modules are connected via twisted-pair cables. The twisted-pair cabling is connected directly to RMsServer .

Free Topology twisted-pair technology allows a nearly infinite number of ways to wire RMS-equipped loudspeakers. However, an individual Free Topology network can address a maximum of 50 loudspeaker nodes over a maximum length of 500 meters (1640 feet) using 20 AWG cable (Belden 8205 or equivalent) and a single bus terminator. A double-terminator topology allows a maximum cable length of 1400 meters (4593 feet) when using 22 AWG cable, and 2700 meters (8858 feet) using 16 AWG cable.

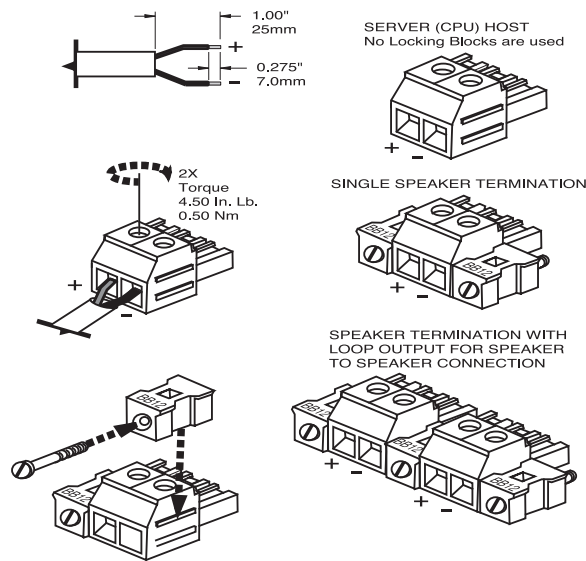

Figure 1: Twisted-pair connectors for RMS-equipped devices

To reduce the amount of twisted-pair cabling in an RMS network, groups of neighboring loudspeakers can be daisy chained. In addition, a twisted-pair cable connected directly to RMsServer can be spliced at a junction box or breakout panel with multiple outputs that can be patched to multiple loudspeaker destinations.

**NOTE:** Multiple RMsServers are required if you want to connect more than 50 device nodes (loudspeakers, etc.) to a host computer running the Compass RMS system. This will increase the data traffic capacity of the network as well as the signal strength over longer cable runs.

### Custom Twisted-Pair Connectors

When designing twisted-pair cable runs, you can use custom connectors (such as 5-pin XLR connectors) or terminal blocks to make the installations more user-friendly. This is common for theater and touring applications.

### Network Terminators

An RMS network terminator is a simple resistive, capacitive device designed to prevent electrical reflections on the network. Each RMsServer contains switchable onboard termination. If needed, additional terminators can be installed at almost any location in the network depending on the topology used.



Figure 2: An RMS network terminator

### Network Repeaters

A network repeater (such as the FTR-120 Free Topology Repeater from MicroComm DXI) connects multiple segments of network cabling. It re-times, strengthens, and regenerates the signal and sends it back to the network. A network repeater allows you to increase the geographical coverage of an RMS network.



Figure 3: FTR-120 Network Repeater

**NOTE:** For information on using the FTR-120 Free Topology Repeater, see Appendix D, “FTR-120 Free Topology Repeater.”

### ETHERNET HUBS AND SWITCHES

A hub is a device that joins multiple computers or other network devices to form a single network. Switches are similar to hubs but are more intelligent; they can inspect data as it is received, determine the source and destination of the data, and forward it appropriately. Switches conserve network bandwidth and offer better performance than hubs.

A hub or a switch is needed for RMS networks containing multiple RMsServers, or if you are sharing an existing Ethernet network connection.

## DESIGN TIPS FOR RMS NETWORKS

Different designs have their own strengths and weaknesses. The following tips will help you make the most of your RMS network design:

- Avoid making “dedicated single runs” for each loudspeaker when designing a system. Make only a single twisted-pair run to loudspeaker locations or arrays when possible. Once you have reached the loudspeaker array location, daisy chain or loop through all the loudspeakers in the array. This will help reduce cable load on the network.



**CAUTION:** If you must make dedicated twisted-pair runs to each loudspeaker (for example, when using VEAM connectors) do not exceed the total recommended cable length (1,640 ft), or plan on using a repeater to minimize data loss.

- Use a single twisted-pair run from the RMServer location to a breakout panel. Locate RMServer as close as possible to the breakout panel, which should itself be located as close as possible to the loudspeakers.
- If you are receiving poor data or experiencing other communications problems, use a terminator in the network to help increase network stability.
- When using a venue’s existing Ethernet-based network, work with the venue’s IT department to reserve static IP addresses for the RMS network.
- When possible, use a closed Ethernet-based network to reduce congestion from outside network activity.

## ETHERNET CONFIGURATIONS

Figure 4, Figure 5, and Figure 6 illustrate some basic Ethernet configurations.

**NOTE:** The maximum length for Ethernet cables is 328 ft (100 m). Do not exceed this length when connecting RMservers to your computer, as well as to Ethernet switches and hubs.

**NOTE:** Ethernet-based RMS systems must conform to Ethernet network design specifications, which are beyond the scope of this manual. A general knowledge of Ethernet networks is very helpful in planning Compass RMS systems.

**NOTE:** A closed, separate Ethernet network is recommended for Compass RMS systems to reduce congestion from outside network traffic. All Galileo units in the system should be on this network.

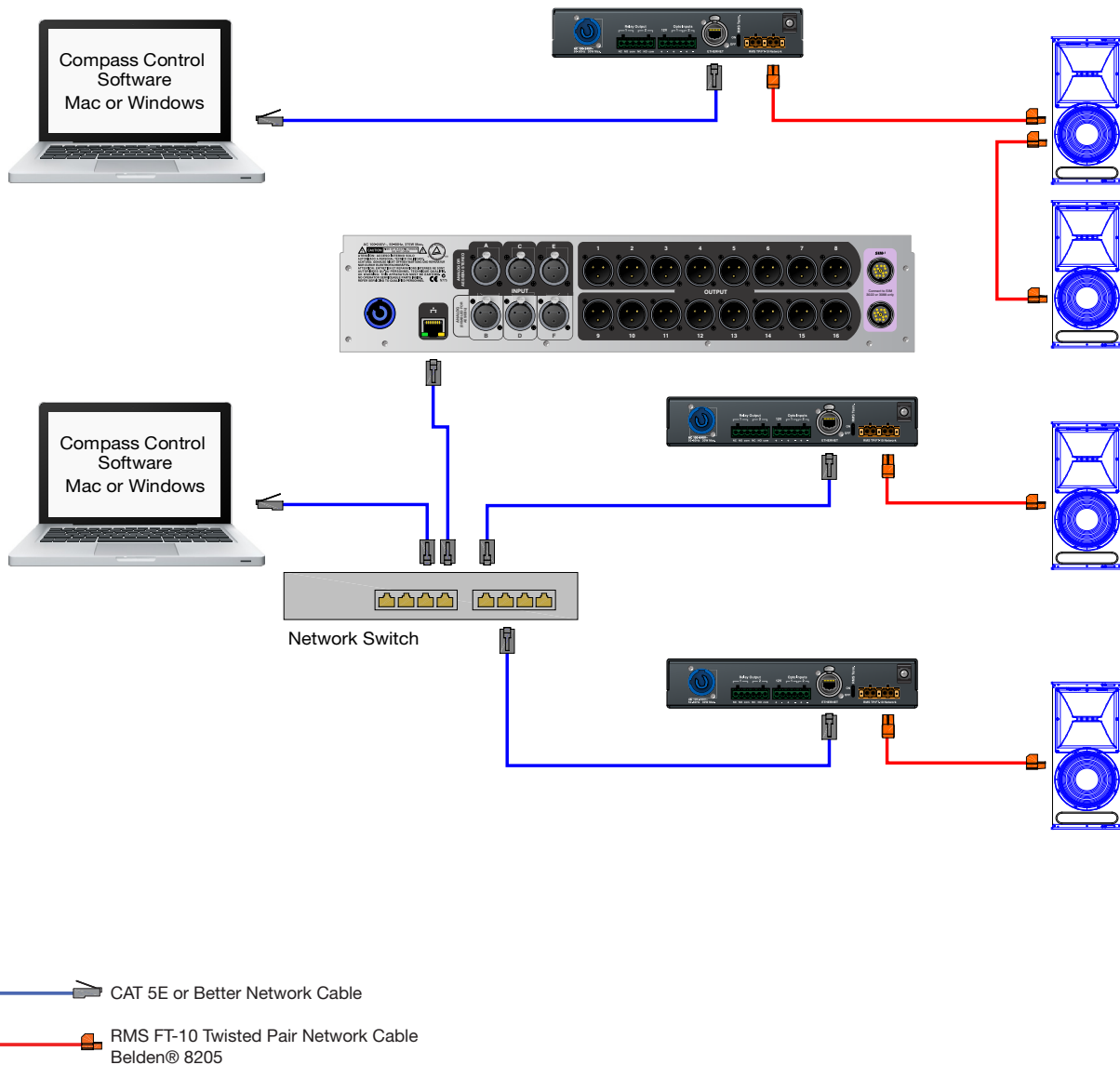

Figure 4: Basic RMS network with a single RMservers (top) and with multiple RMservers, Callisto, and a router (bottom).

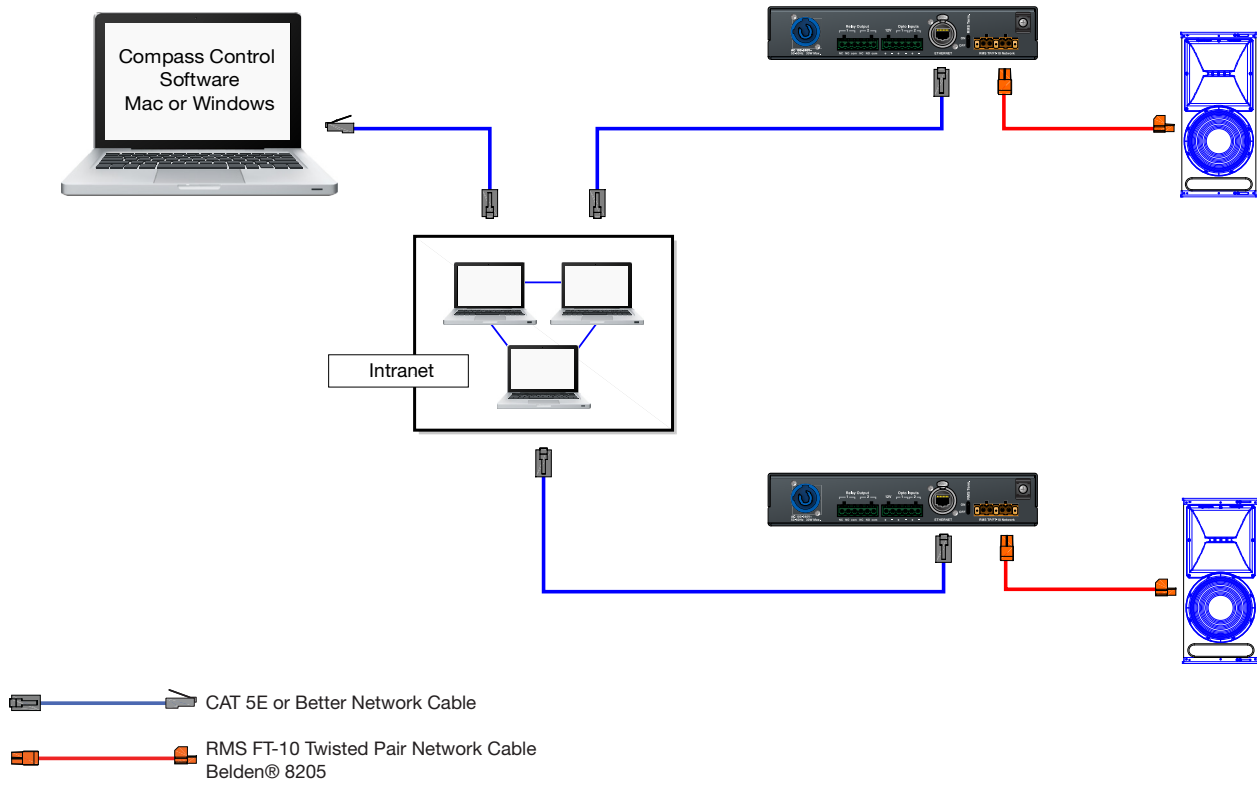

Figure 5: Basic Ethernet Configuration Using Existing Intranet Infrastructure

### Ethernet and Twisted-Pair Hybrid System (Large Venue Applications)

For larger venues such as theatres, stadiums, arenas, hotels, and theme parks, systems using multiple RMServers are preferred for increased network speed.

In large systems, long cable runs can be required from an RMServer to the loudspeaker locations. One or more FTR-120 repeaters can be incorporated to extend the maximum cable run length. This forms a hybrid network of twisted-pair and Ethernet cabling.

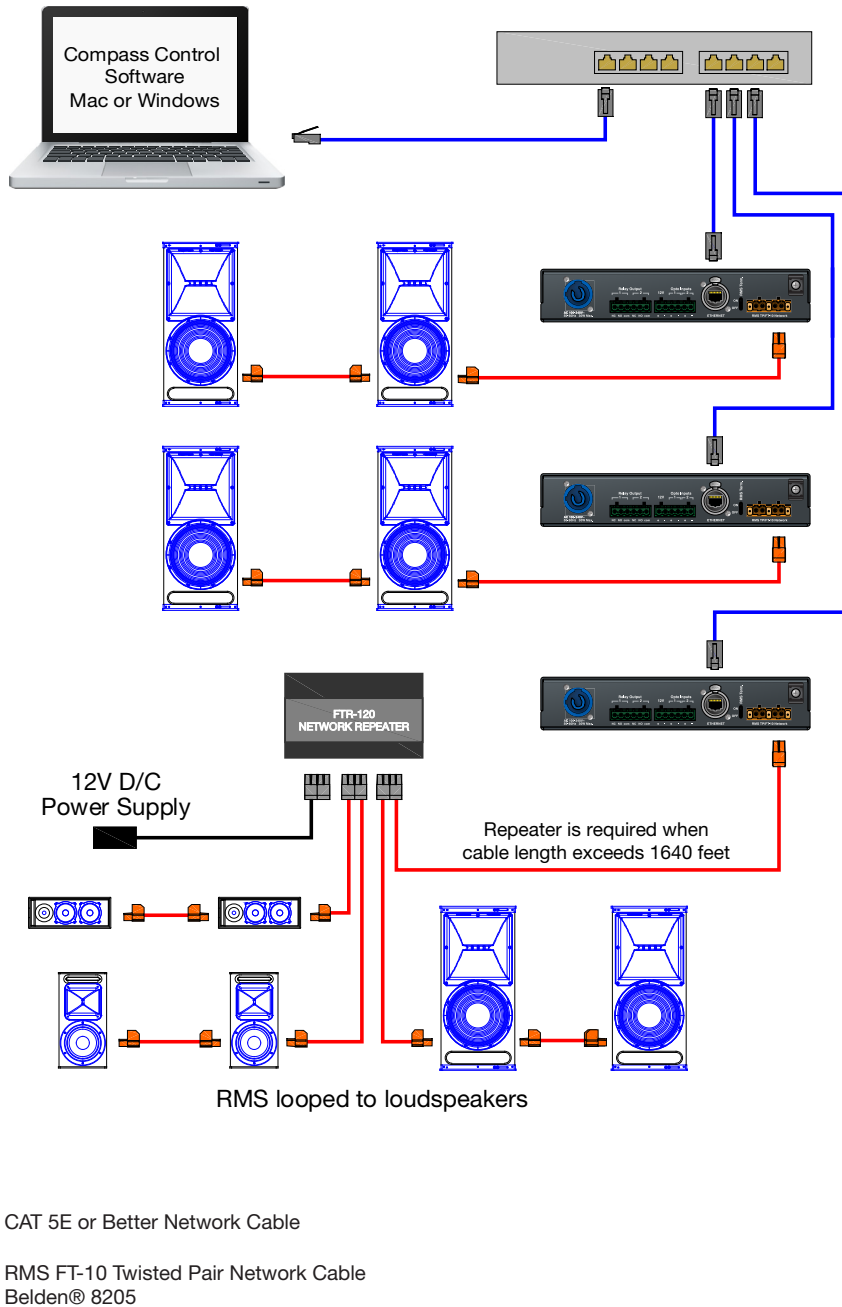

Figure 6: A large system using an FTR-120 repeater.

## Star Topology with Low Voltage Systems and Junction Point

The MPS-488HP power supply is used in low-voltage systems. It is important to note that each MPS-488HP consumes four RMS nodes, regardless of how many loudspeakers are actually connected to it. The junction point illustrates the flexibility of a free topology network.

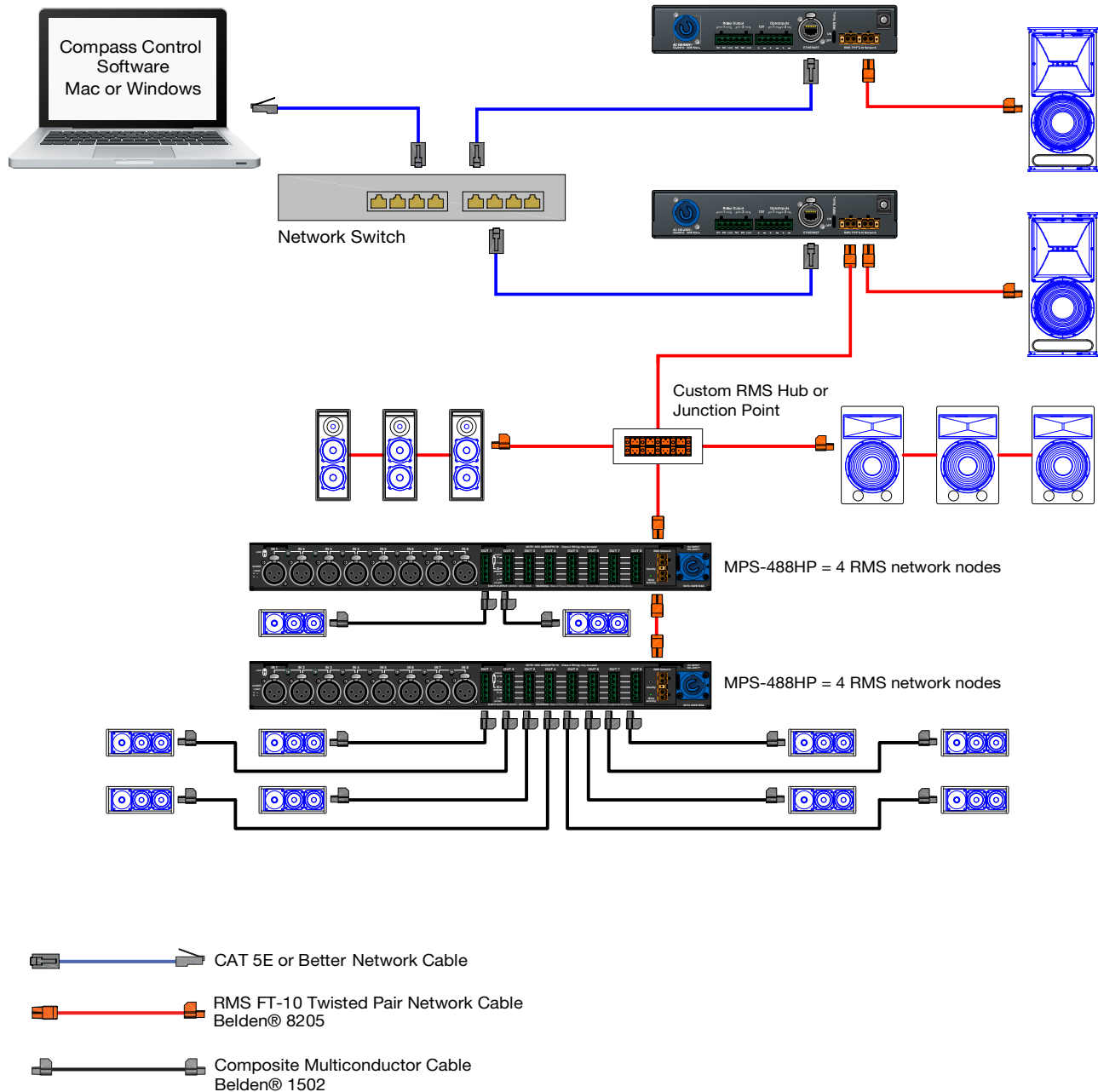

Figure 7: A large system using a junction box and multiple MPS-488HPs. All junction point output ports are in parallel.





## CHAPTER 4: HP/MP RMS MODULE

The HP/MP RMS module is used in the following loudspeakers with HP-2, HP-4, MP-2, and MP-4 amplifiers.

**Table 1: MP/HP Amplifier RMS Module**

Part Number	Series	Loudspeakers
40.033.071.01	M-Series	M2D-Sub, M3D, M3D-Sub, MICA, MILO 60, MILO 120
	Concert Series	600-HP, 700-HP, 650-P, DF-4, DS-2P, DS-4P, MSL-4, MSL-6, MTS-4, PSM-2, PSW-2, PSW-4, PSW-6,
	Industrial Series	SB-1, SB-2, SB-3F
	EXP Series	Acheron 100, Acheron 80, Acheron LF

When equipped with an RMS module, Meyer Sound loudspeakers can be connected to an RMS network and monitored with Compass control software. Some Meyer Sound loudspeakers, such as the M-Series loudspeakers, come standard with an RMS module already installed. For other Meyer Sound loudspeakers, an RMS module is available as an option that can either be factory installed or installed at a later date by a qualified service technician.

The following sections document how to install and use the HP/MP RMS module:

- “Installing the HP/MP RMS Module” on page 29
- “Installing the Mute Jumper on the HP/MP RMS Module” on page 33
- “HP/MP RMS User Panel” on page 34
- “Neuron ID for HP/MP RMS Modules” on page 34
- “Resetting the HP/MP RMS Module” on page 35

 **NOTE:** The HP/MP RMS module includes a Mute Jumper that enables the loudspeaker’s mute and solo capability when installed. Meyer Sound currently ships RMS-equipped loudspeakers with the Mute Jumper installed. These mute-enabled loudspeakers can be identified by the blue “ME” sticker on the HP/MP RMS user panel. Older RMS-equipped loudspeakers can be easily mute-enabled by installing the Mute Jumper. For more information, see “Installing the Mute Jumper on the HP/MP RMS Module” on page 33.

### INSTALLING THE HP/MP RMS MODULE

This section documents installing the HP/MP RMS module. The installation procedure requires the following:

- Standard #2 Phillips screwdriver
- 3/8-inch nut driver
- Fluke 87 multimeter or equivalent ohmmeter

 **NOTE:** Before adding an RMS module to loudspeakers with amplifiers manufactured before 1997, the loudspeakers must be retrofitted with TPL control boards and RMS-ready user panels. The first two digits of the loudspeaker’s serial number indicate its year of manufacture; serial numbers starting with 96 or a lower number require retrofitting. For information, contact Meyer Sound Technical Services.

 **NOTE:** Make sure to hold the HP/MP RMS module by its edges. Avoid touching any of the components on the module.

To install the HP/MP RMS module:

1. Remove the loudspeaker’s AC power cable and audio cable and place the loudspeaker on a clean, low-static firm surface. Orient the loudspeaker with the top facing up. Wait at least five minutes before removing the HP/MP RMS module.

2. To remove the amplifier from the loudspeaker cabinet:

- Remove the eight large screws that secure the amplifier to the cabinet.

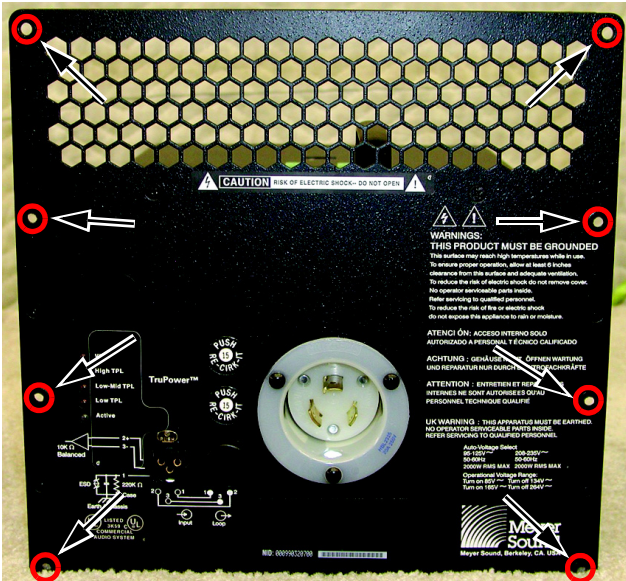

- Remove the amplifier from the cabinet slowly, taking care to unplug the green loudspeaker connector on the top side of the amplifier (there are two connectors for the four-channel amplifiers).

- Place the amplifier on a flat surface that is stable, clean, and low-static.

3. To remove the user panel from the amplifier:

- Remove the eight small screws from the user panel.

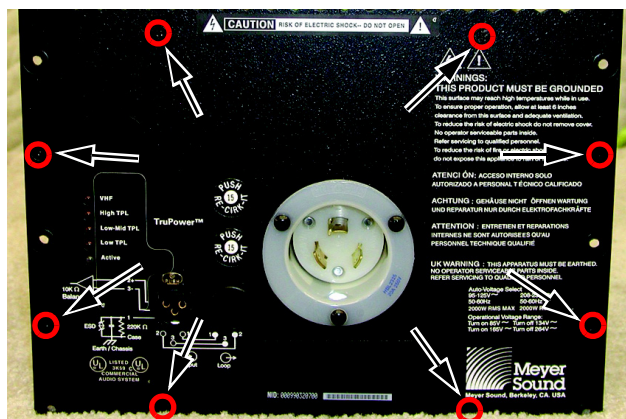

- While carefully removing the user panel, disconnect from the user panel the signal cable from the input board (with the gray connector), and disconnect from the AC mains board the AC input cable (4-wire, green connector) from the user panel.

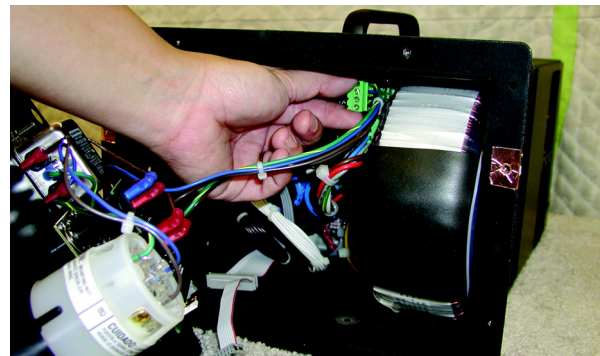
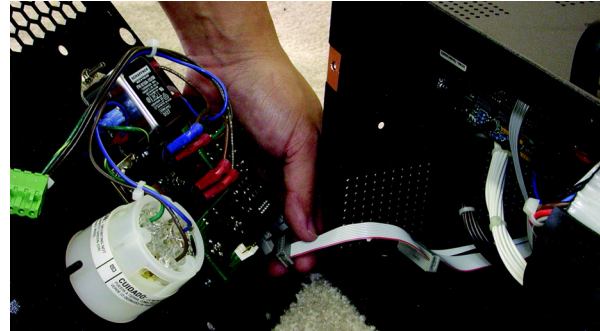

4. Remove the blank cover plate from the user panel by removing the two nuts on the back of the user panel.

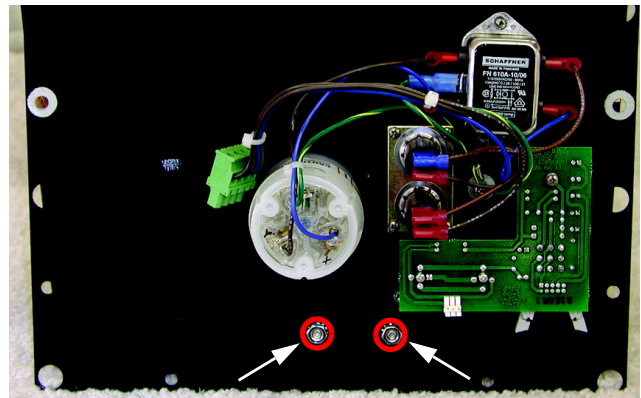

5. In the power supply chassis, locate the back right screw hole (next to the transformer) on the floor of the chassis. If the paint around the hole has not been sufficiently removed (to allow for metal-to-metal contact with the

module standoff), remove the paint with a Dremel® tool or sandpaper. Make sure to remove all debris from the chassis before proceeding.

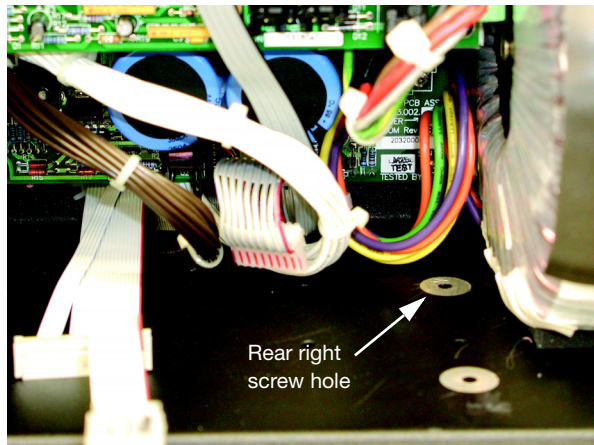

**CAUTION:** Do not grind down the metal around the screw hole too much. If the metal is too thin it will reduce the metal-to-metal contact (and grounding) with the HP/MP RMS module.

- Remove the plastic connector on the power supply board (next to the fan power connector).

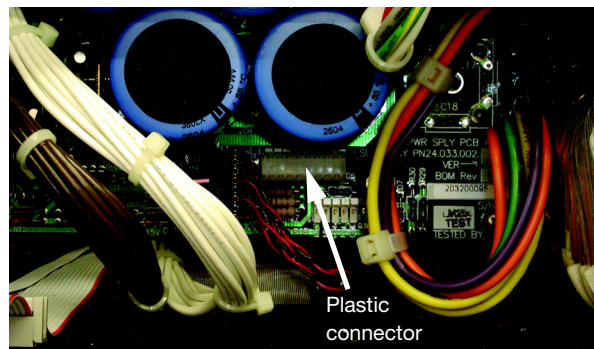

- Apply one drop of Loctite® to each of the four standoffs on the HP/MP RMS module and then place the module in the bottom of the power supply chassis with the LEDs facing out and the standoffs aligned with the four screw holes in the bottom of the chassis.

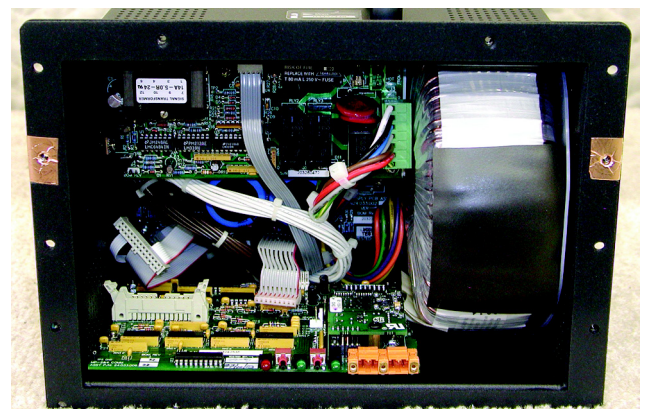
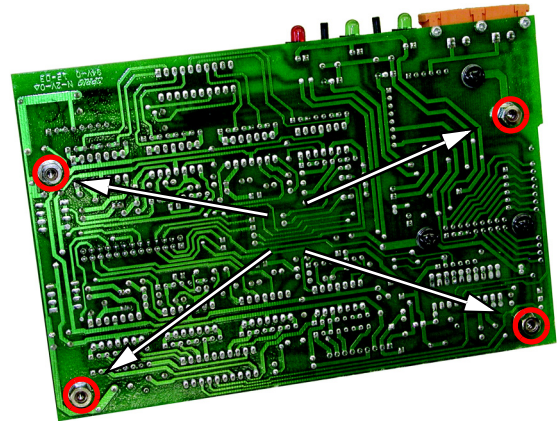



- Attach the short 9-wire gray ribbon cable from the HP/MP RMS module to the connector on the power supply board. Make sure all pins are engaged and that the connector is firmly seated.

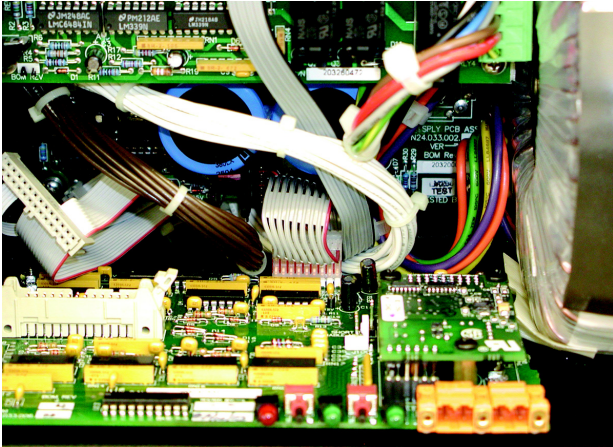

- Attach the 26-pin connector from the long ribbon cable to the HP/MP RMS module connector. Make sure to fully lock the connector.

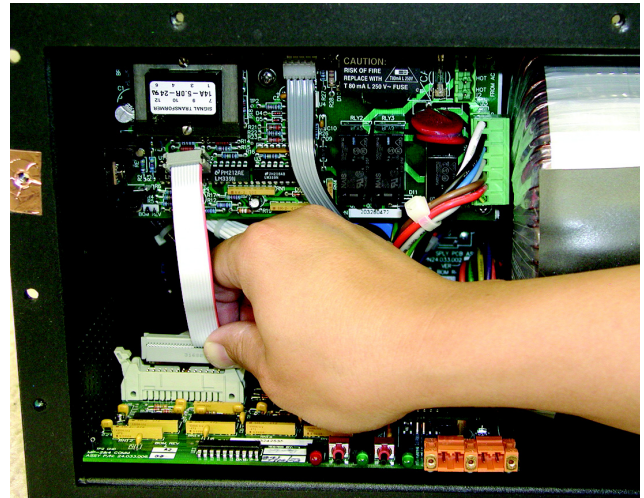

- While holding the HP/MP RMS module in place, place the loudspeaker on its side and secure the module using the four screws included with the kit.

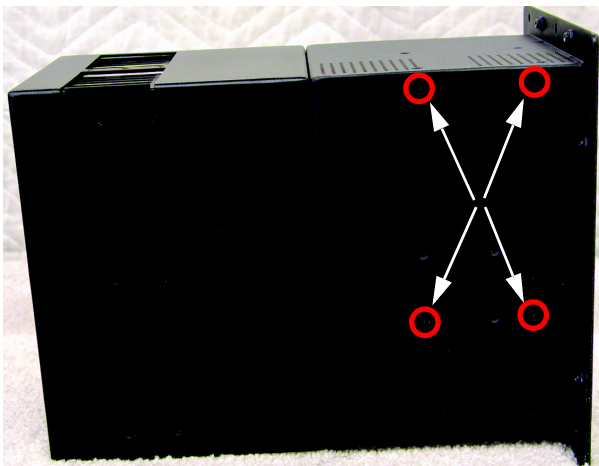

- Using an ohmmeter, measure the resistance for R13 on the HP/MP RMS module. R13 is located about an inch to the right of the center of the module. The resistance should measure 10 ohms. If the resistance measures 47 ohms, the module is insufficiently grounded.

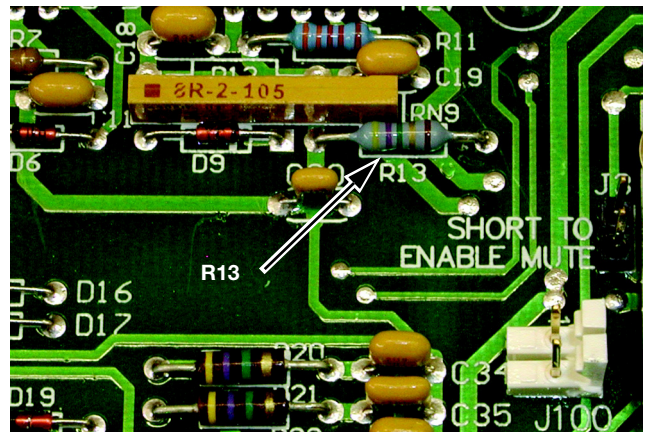

**NOTE:** Insufficient grounding may be caused by too much paint surrounding the back right screw hole (see Step 5), or it may be caused by over-thinning the screw hole (if this is the case, a shorter screw may fix the problem).

**NOTE:** The resistance for R13 will not read 10 ohms if the ribbon cable from the HP/MP RMS module was not connected to the power supply board (see Step 8).

12. Reconnect the AC input cable (4-wire, green connector) from the user panel to the AC mains board. Reconnect the signal cable from the input board (gray multipin connector) to the user panel. Make sure to fully lock the gray multipin connector.

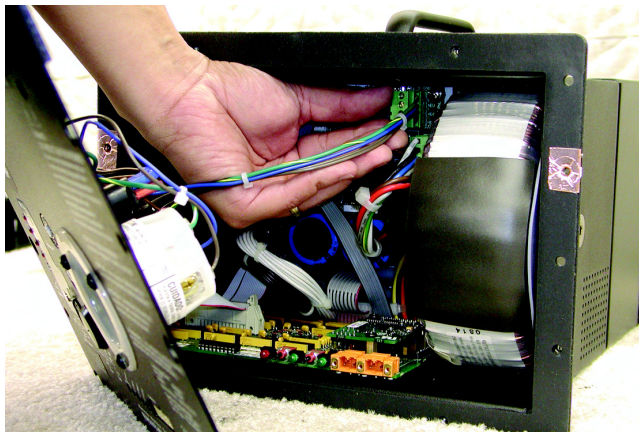

13. While carefully aligning the HP/MP RMS module's network connectors and LEDs with the user panel, secure the user panel to the amplifier with the eight small screws.
14. Reconnect the green connector from the loudspeaker cabinet to the top of the amplifier (there are two connectors for the four-channel amplifiers), then carefully slide the amplifier back in the cabinet and secure it with the eight large screws.
15. Affix the Neuron ID label to the bottom center of the user panel, directly below the HP/MP RMS module's LEDs and network connectors.



Neuron ID label

16. Reconnect the loudspeaker's AC power cable and audio cable and apply power to the loudspeaker. The Activity LED blinks to indicate the HP/MP RMS module is operational and ready to be discovered on the network.

## INSTALLING THE MUTE JUMPER ON THE HP/MP RMS MODULE

To use the mute and solo functions of the HP/MP RMS module, the Mute Jumper must be installed on the module. Meyer Sound currently ships RMS-equipped loudspeakers with the Mute Jumper installed. These mute-enabled loudspeakers can be identified by the blue "ME" sticker on the HP/MP RMS user panel. Older RMS-equipped loudspeakers can be easily mute-enabled by installing the Mute Jumper, available from Meyer Sound in a mute jumper kit, P/N 476.005 RMS Mute Enable Replacement Upgrade Jumper.



ME Sticker

To install the Mute Jumper on the HP/MP RMS module:

1. Remove the loudspeaker's AC power cable and then wait at least five minutes before removing the HP/MP RMS module.
2. On the HP/MP RMS module, locate the two (J3) jumper pins labeled SHORT TO ENABLE MUTE and install the blue Mute Jumper on these two pins.



RMS Mute Jumper

Install here

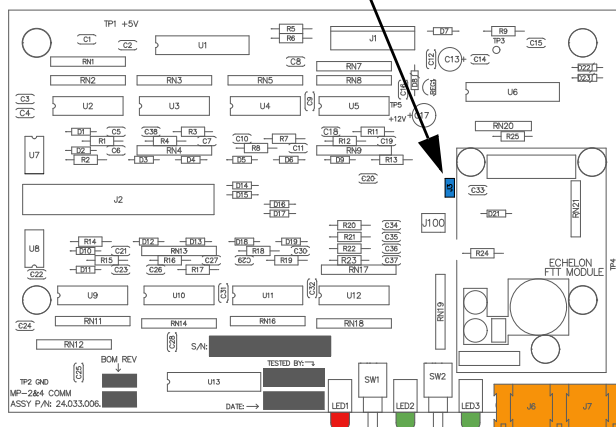

HP/MP RMS Module Jumper Pins



**CAUTION:** Do not mistakenly install the Mute Jumper on the white, unlabeled two-pin connector on the HP/MP RMS module. This connector is for the VEAM connector option; using it for any other purpose will damage the module.

3. Reinstall the HP/MP RMS module in the loudspeaker.

## HP/MP RMS USER PANEL

The HP/MP RMS user panel has three LEDs, two buttons, and two Network connectors.

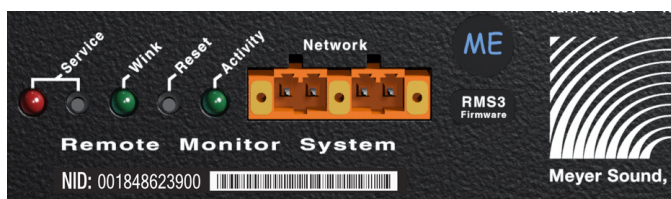

Figure 8: HP/MP RMS Module



**NOTE:** The buttons and LED on the HP/MP RMS user panel are used exclusively by Compass RMS and have no effect on the acoustical or electrical activity of the loudspeaker.

### Service LED (Red)

The red Service LED provides the following feedback:

- When unlit, the loudspeaker is successfully connected to the network and discovered.
- When blinking once every two seconds, the loudspeaker is connected to the network but not yet discovered in Compass.
- When lit continuously, the loudspeaker's RMS hardware has failed and may indicate that the module has been damaged (contact Meyer Sound Technical Support).

### Service Button

Pressing the Service button identifies the loudspeaker in the Compass RMS system and notifies Compass that the loudspeaker is connected. You can simultaneously press the Reset and Service buttons to reset the HP/MP RMS module, undiscover the loudspeaker, and remove it from the RMServer inventory (see “Resetting the HP/MP RMS Module” on page 35).

### Wink LED (Green)

The green Wink LED lights when a signal is sent from Compass by clicking the Wink button on a loudspeaker object in meter view on a user page. This is useful for identifying the physical loudspeaker corresponding to a loudspeaker icon in Compass.

### Reset Button

Pressing the Reset button causes the HP/MP RMS module's firmware to reboot; this will not affect whether the loudspeaker is discovered (which is stored in flash memory). You can simultaneously press the Reset and Service buttons to reset the HP/MP RMS module, undiscover the loudspeaker, and remove it from the RMServer inventory (see “Resetting the HP/MP RMS Module” on page 35).

### Activity LED (Green)

The green Activity LED flashes continuously when the loudspeaker has been successfully discovered.

### RMS Network Connectors

The two Weidmuller connectors transfer data to and from the RMS network. Two connectors are provided to allow for easy connection of multiple (daisy-chained) loudspeakers on the network. Included with each RMS-equipped loudspeaker are RMS cable connectors and mounting blocks for constructing RMS cables. The RMS blocks allow the cables to be securely attached to the RMS module with screws.

### NEURON ID FOR HP/MP RMS MODULES

Each HP/MP RMS module has a unique 12-character Neuron ID (NID) that identifies the loudspeaker on the network. The NID should be discovered automatically by the RMServer to which it is connected, but can be entered manually, if necessary. The NID for the HP/MP RMS module is located on the user panel below the orange RMS Network connectors (see Figure 8 on page 34).

## RESETTING THE HP/MP RMS MODULE

You can use the Reset and Service buttons to reset the HP/MP RMS module, which will cause the module to be undiscovered and removed from the RMServer inventory.

To reset the HP/MP RMS module:

1. Press and hold the Service button for 10 seconds.
2. While continuing to hold down the Service button, press and hold the Reset button for 5 seconds.
3. After releasing the Reset button, continue holding down the Service button for 5 seconds. The HP/MP RMS module is reset and the loudspeaker is undiscovered and removed from the RMServer inventory. The HP/MP RMS module's red Service LED blinks.





## CHAPTER 5: ULTRASERIES RMS MODULE

There are two UltraSeries RMS modules, which are used in the following loudspeakers.

**Table 2: UltraSeries RMS Modules**

Part Number	Series	Loudspeakers
40.084.008.01 (UX)	M-Series	M1D, MD1-Sub, M'elodie
	UltraSeries	500-HP, JM-1P, MJF-212, MJF-212A, UMS-1P, UPJ-1P, UPJunior, UPM-1P, UPM-2P, UPQ-1P, UPQ-2P
	JM Series	JM-1P
40.076.028.01 (UPM)	M-Series	M2D
	UltraSeries	UPA-1P, UPA-2P, UM-1P, UM-100P, USM-1P, USM-100, USW-1P
	EXP Series	Acheron Studio

When equipped with an RMS module, Meyer Sound loudspeakers can be connected to an RMS network and monitored with Compass. Some Meyer Sound loudspeakers, such as the M-Series loudspeakers, come standard with the RMS module already installed. For other Meyer Sound loudspeakers, the RMS module is available as an option that can either be factory installed or installed at a later date by a qualified service technician.

The following sections document how to install and use the UltraSeries RMS module:

- “Installing the UltraSeries RMS Module” on page 37
- “Installing the Mute Jumper on the UltraSeries RMS Module” on page 38
- “UltraSeries RMS User Panel” on page 39
- “Neuron ID for UltraSeries RMS Modules” on page 40
- “Resetting the UltraSeries RMS Module” on page 40

 **NOTE:** The UltraSeries RMS module includes a Mute Jumper that when installed enables the loudspeaker’s mute and solo capability. Meyer Sound currently ships RMS-equipped loudspeakers with the Mute Jumper installed. These mute-enabled loudspeakers can be identified by the blue “ME” sticker on the UltraSeries RMS user panel. Older RMS-equipped loudspeakers can be easily mute-enabled

by installing the Mute Jumper. For more information, see “Installing the Mute Jumper on the UltraSeries RMS Module” on page 38.





*ME Sticker*

### INSTALLING THE ULTRASERIES RMS MODULE

This section documents installing the RMS module in UltraSeries loudspeakers. The same procedure can also be used to install or replace an RMS module in several of the M-Series loudspeakers (see Table 2). This installation procedure requires a standard #2 Phillips screwdriver.

 **NOTE:** If you want to enable muting capability for the loudspeaker, make sure to install the Mute Jumper on the RMS module before installing it. For more information, see “Installing the Mute Jumper on the UltraSeries RMS Module” on page 38.

 **NOTE:** The illustrations in the following procedure show the UltraSeries UX RMS module. However, this procedure is the same for UltraSeries UPM RMS modules.

 **NOTE:** Make sure to hold the UltraSeries RMS module by its edges. Avoid touching any of the components on the module.

To install the UltraSeries RMS module:

1. Remove the loudspeaker's AC power cable and audio cable and place the loudspeaker on a clean, low-static flat surface. Orient the loudspeaker with the top facing up. Wait at least five minutes before removing the UltraSeries RMS module.
2. Remove the four screws securing the cover plate for the slot below the audio input module. Save the cover plate in case you need it in the future.

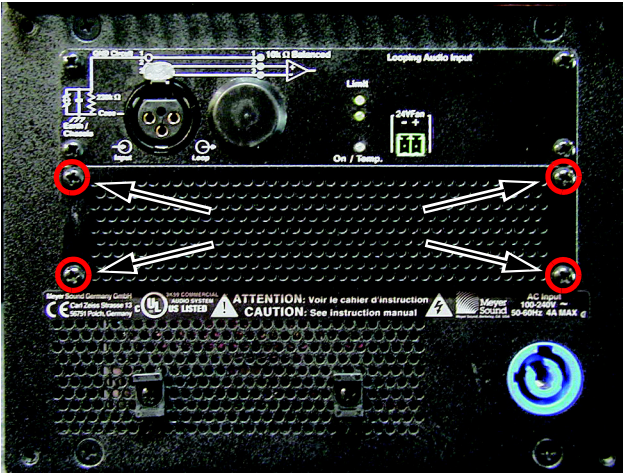

3. Verify that the copper strip on the left side of the open slot is not damaged and properly positioned. The copper strip helps ground the UltraSeries RMS module to the chassis. If you need to replace the copper strip, contact Meyer Sound.

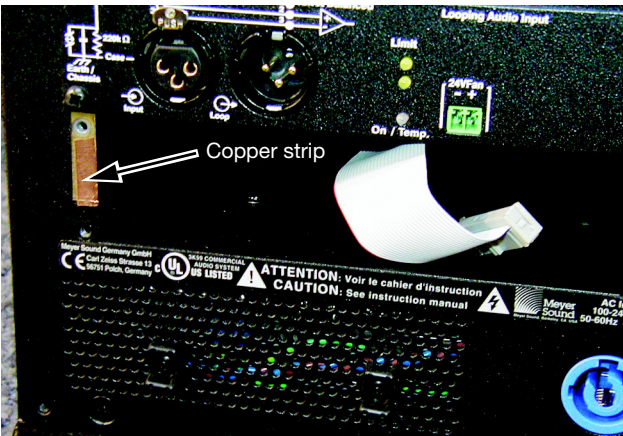

4. Locate the ribbon cable beneath the audio input module and attach this cable to the rear connector on the UltraSeries RMS module. Make sure to fully lock the connector.

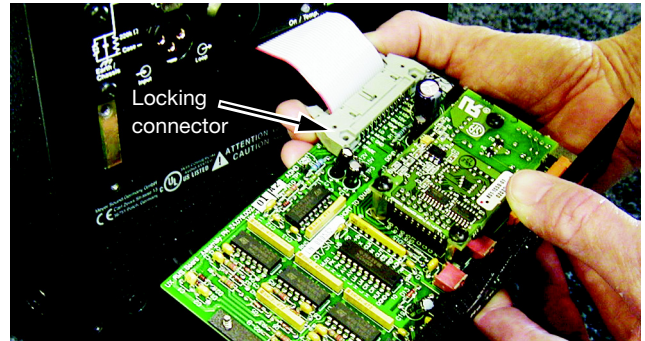

5. Slide the UltraSeries RMS module into the open slot (below the audio input module) and secure it with the four screws.
6. Reconnect the loudspeaker's AC power cable and audio cable and apply power to the loudspeaker. The Activity LED blinks to indicate the UltraSeries RMS module is operational and ready to be discovered on the network.

### INSTALLING THE MUTE JUMPER ON THE ULTRASERIES RMS MODULE

To use the mute and solo functions of the UltraSeries RMS module, the Mute Jumper must be installed on the module. Meyer Sound currently ships RMS-equipped loudspeakers with the Mute Jumper installed. These mute-enabled loudspeakers can be identified by the blue "ME" sticker on the UltraSeries RMS user panel. Older RMS-equipped loudspeakers can be easily mute-enabled by installing the Mute Jumper, available from Meyer Sound in a mute jumper kit, P/N 476.005 RMS Mute Enable Replacement Upgrade Jumper.

**CAUTION:** Do not mistakenly install the Mute Jumper on the white, unlabeled two-pin connector on the UltraSeries RMS module. This connector is for the VEAM connector option; using it for any other purpose will damage the module.

To install the Mute Jumper on the UltraSeries RMS module:

1. Remove the loudspeaker's AC power cable and then wait at least five minutes before removing the UltraSeries RMS module.
2. On the UltraSeries RMS module, locate the two (J3) jumper pins labeled SHORT TO ENABLE MUTE and install the blue Mute Jumper on these two pins.



RMS Mute Jumper

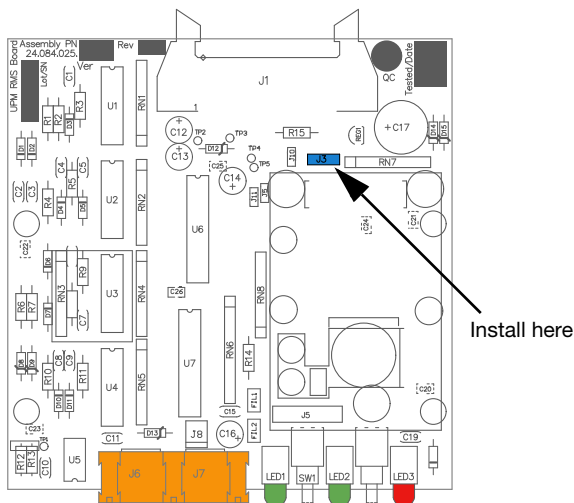

UltraSeries (UPM) RMS Module Mute Jumper Pins

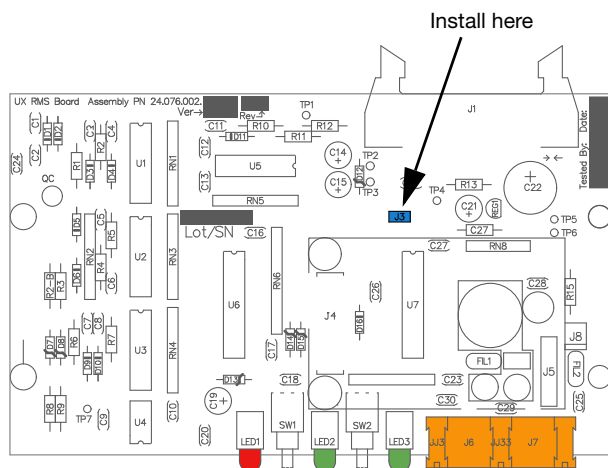

UltraSeries (UX) RMS Module Mute Jumper Pins

3. Reinstall the UltraSeries RMS module in the loudspeaker.

## ULTRASERIES RMS USER PANEL

The UltraSeries RMS user panel has three LEDs, two buttons, and two Network connectors.

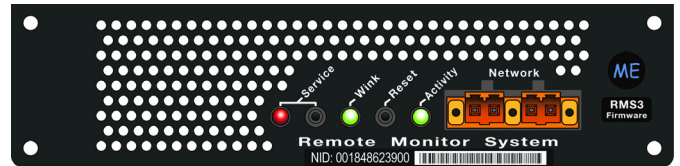

Figure 9: UltraSeries RMS Module (UX, PN 40.084.008.01)



Figure 10: UltraSeries RMS Module (UPM, PN 40.076.028.01)

**NOTE:** The buttons and LEDs on the UltraSeries RMS user panel are used exclusively by Compass RMS and have no effect on the acoustical or electrical activity of the loudspeaker.

### Service LED (Red)

The red Service LED provides the following feedback:

- When unlit, the loudspeaker is successfully connected to the network and discovered.
- When blinking once every two seconds, the loudspeaker is connected to the network but not yet discovered in Compass.
- When lit continuously, the loudspeaker's RMS hardware has failed and may indicate that the module has been damaged (contact Meyer Sound Technical Support).

### Service Button

Pressing the Service button identifies the loudspeaker in the Compass RMS system and notifies Compass that the loudspeaker is connected. You can simultaneously press the Reset and Service buttons to reset the UltraSeries RMS module, undiscover the loudspeaker, and remove it from the RMsServer inventory (see "Resetting the UltraSeries RMS Module" on page 40).

## Wink LED (Green)

The green Wink LED lights when a signal is sent from Compass by clicking the Wink button on a loudspeaker object in meter view on a user page. This is useful for identifying the physical loudspeaker corresponding to a loudspeaker icon in Compass.

## Reset Button

Pressing the Reset button causes the UltraSeries RMS module's firmware to reboot; this will not affect whether the loudspeaker is discovered (which is stored in flash memory). You can simultaneously press the Reset and Service buttons to reset the UltraSeries RMS module, undiscover the loudspeaker, and remove it from the RMServer inventory (see "Resetting the UltraSeries RMS Module" on page 40).

## Activity LED (Green)

The green Activity LED flashes continuously when the loudspeaker has been successfully discovered

## RMS Network Connectors

The two Weidmuller connectors transfer data to and from the RMS network. Two connectors are provided to allow for easy connection of multiple (daisy-chained) loudspeakers on the network. Included with each RMS-equipped loudspeaker are RMS cable connectors and mounting blocks for constructing RMS cables. The RMS blocks allow the cables to be securely attached to the RMS module with screws.

## NEURON ID FOR ULTRASERIES RMS MODULES

Each UltraSeries RMS module has a unique 12-character Neuron ID (NID) that identifies the loudspeaker on the network. The NID should be discovered automatically by the RMServer to which it is connected, but can be entered manually, if necessary. The NID for the UltraSeries RMS module is located on the user panel below the orange RMS Network connectors (see Figure 9 on page 39 and Figure 10 on page 39).

## RESETTING THE ULTRASERIES RMS MODULE

You can use the Reset and Service buttons to reset the UltraSeries RMS module, which will cause the module to be reset, and loudspeaker to be undiscovered and removed from the RMServer inventory.

To reset the UltraSeries RMS module:

1. Press and hold the Service button for 10 seconds.
2. While continuing to hold down the Service button, press and hold the Reset button for 5 seconds.
3. After releasing the Reset button, continue holding down the Service button for 5 seconds. The UltraSeries RMS module is reset and the loudspeaker is undiscovered and removed from the RMServer inventory. The UltraSeries RMS module's red Service LED blinks.

## CHAPTER 6: DX RMS MODULE

The DX RMS module is used in the following loudspeakers:

- M-Series MINA loudspeaker (comes standard)
- EXP Acheron Designer loudspeaker (optional)
- X-400C subwoofer (optional)
- MJF-210 stage monitor (optional)

When equipped with an RMS module, Meyer Sound loudspeakers can be connected to an RMS network and monitored with Compass control software. Some Meyer Sound loudspeakers, such as MINA, come standard with the RMS module already installed. For other Meyer Sound loudspeakers, the RMS module is available as an option that can either be factory installed or installed at a later date by a qualified service technician.

The following sections document how to install and use the DX RMS module:

- “Installing the DX RMS Module” on page 41
- “DX RMS User Panel” on page 41
- “Neuron ID for DX RMS Modules” on page 42
- “Resetting the DX RMS Module” on page 42

### INSTALLING THE DX RMS MODULE

This section documents installing the DX RMS module. This installation procedure requires a standard #2 Phillips screwdriver

 **NOTE:** Make sure to hold the DX RMS module by its edges. Avoid touching any of the components on the module.

To install the DX RMS module:

1. Remove the loudspeaker’s AC power cable and audio cable and place the loudspeaker on a clean, low-static flat surface. Orient the loudspeaker with the top facing up. Wait at least five minutes before removing the DX RMS module.
2. Remove the two screws securing the cover plate for the slot below the audio input module. Save the cover plate in case you need it in the future.
3. Locate the ribbon cable beneath the audio input module and attach this cable to the rear connector on the DX RMS module. Make sure to fully lock the connector.

4. Slide the DX RMS module into the open slot (below the audio input module) and secure it with the two screws.
5. Reconnect the loudspeaker’s AC power cable and audio cable and apply power to the loudspeaker.

 **NOTE:** The RMS modules in Acheron Designer, MINA, and X-400C cannot be interchanged with modules for other loudspeaker models.

### DX RMS USER PANEL

The DX RMS user panel includes an Identify button, Wink/Activity LED, Remote Mute switch, and two Network connectors.

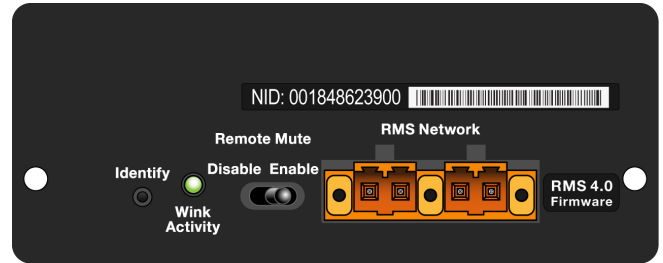



Figure 11: DX RMS Module

 **NOTE:** The button and LEDs on the DX RMS user panel are used exclusively by Compass RMS and have no effect on the acoustical or electrical activity of the loudspeaker.

### Identify Button

The Identify button serves the following functions:

- If the loudspeaker has not yet been discovered (Wink/Activity LED not lit), press the Identify button to identify the loudspeaker in the Compass RMS system and discover it.
- To undiscover the loudspeaker and remove it from the RMServer inventory, press and hold the Identify button during startup (see “Resetting the DX RMS Module” on page 42).
- To *wink* a discovered loudspeaker, press the Identify button. The Wink LED on the loudspeaker icon in Compass lights up and the Wink/Activity LED on the loudspeaker’s RMS user panel turns solid green. Press the Identify button again to unwink the loudspeaker



## Wink/Activity LED (Green)

The green Wink/Activity LED indicates the status of the loudspeaker:

- During startup, the LED blinks 10 times.
- If the loudspeaker has not yet been discovered, the LED is not lit after startup.
- If the loudspeaker has been successfully discovered, the LED flashes continuously and flashes more rapidly with increased data activity.
- When the loudspeaker is winked, either by clicking the Wink button in Compass or by pressing the Identify button on the RMS user panel, the LED is solid green.



**TIP:** The Wink function is useful for identifying the physical loudspeaker corresponding to a loudspeaker object in Compass.

## Remote Mute Switch

The recessed Remote Mute switch on the DX RMS user panel determines whether Compass can control muting and soloing of the loudspeaker. The DX RMS module ships from the factory with the switch enabled.

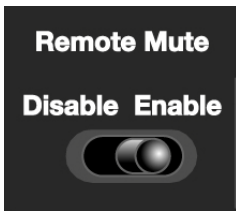

*RMS Module*

- **Disable:** When the Remote Mute switch is set to Disable (to the left), the loudspeaker cannot be muted and soloed from Compass.
- **Enable:** When the Remote Mute switch is set to Enable (to the right), the loudspeaker can be muted and soloed from Compass.

## RMS Network Connectors

The two Weidmuller connectors transfer data to and from the RMS network. Two connectors are provided to allow for easy connection of multiple (daisy-chained) loudspeakers on the network. Included with each RMS-equipped loudspeaker are RMS cable connectors and mounting blocks for constructing RMS cables. The RMS blocks allow the cables to be securely attached to the RMS module with screws.

## NEURON ID FOR DX RMS MODULES

Each DX RMS module has a unique 12-character Neuron ID (NID) that identifies the loudspeaker on the network. The NID should be discovered automatically by the RMServer to which it is connected, but can be entered manually, if necessary. The NID for the DX RMS module is located on the user panel above the orange RMS Network connectors (see Figure 11 on page 41).

## RESETTING THE DX RMS MODULE

You can use the Identify button to reset the DX RMS module when powering up the loudspeaker. This will cause the module to be reset, and the loudspeaker to be undiscovered and removed from the RMServer inventory.

To reset the DX RMS module:

1. Disconnect the loudspeaker's power cord.
2. Press and hold the Identify button.
3. While continuing to hold down the Identify button, reconnect the power cord.
4. After the Wink/Status LED blinks on and off, release the Identify button. The DX RMS module is reset and the loudspeaker is undiscovered and removed from the RMServer inventory.

## CHAPTER 7: MX RMS MODULE

The MX RMS module is used in the following loudspeakers:

- LEO-M loudspeaker (comes standard)
- 1100-LFC loudspeaker (comes standard)

When equipped with an RMS module, Meyer Sound loudspeakers can be connected to an RMS network and monitored with Compass control software. Some Meyer Sound loudspeakers, including LEO-M and 1100-LFC, come standard with the RMS module already installed. For other Meyer Sound loudspeakers, the RMS module is available as an option that can either be factory installed or installed at a later date by a qualified service technician.

The following sections document how to install and use the MX RMS module:

- “Installing the MX RMS Module” on page 43
- “Installing the Mute Jumper on the MX RMS Module” on page 45
- “Neuron ID for MX RMS Modules” on page 46
- “Resetting the MX RMS Module” on page 46

### INSTALLING THE MX RMS MODULE

This section documents installing the MX RMS module. This installation procedure requires a standard #2 Phillips screwdriver.

To install the MX RMS module:

1. Remove the loudspeaker’s AC power cable and audio cable and place the loudspeaker on a clean, low-static flat surface. Orient the loudspeaker with the top facing up. Wait at least five minutes before removing the MX RMS module.
2. Remove the six screws securing the rear panel.

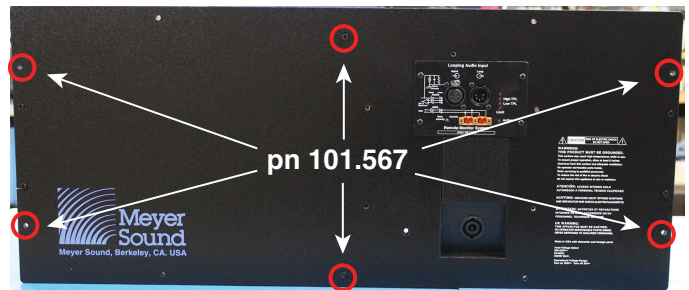

3. Disconnect the AC power connector.

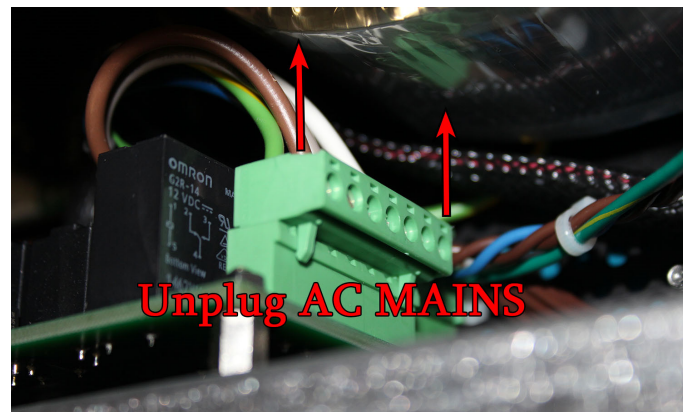

- Lift out the user panel.

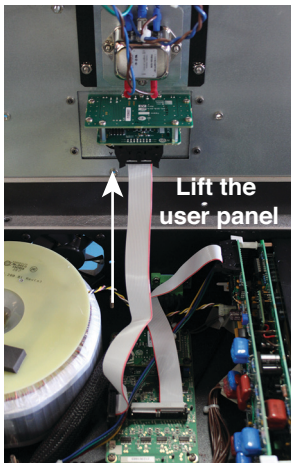

 **NOTE:** Make sure to hold the MX RMS module by its edges. Avoid touching any of the components on the module.

- Disconnect the ribbon cable from the interconnect Input/RMS module.

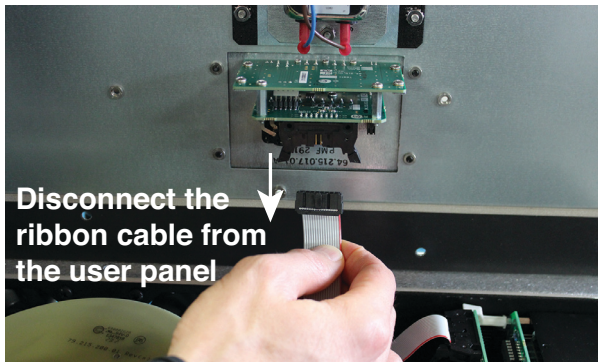

- The main RMS PCBA module is attached to the amplifier chassis, as can be seen in this top view.



- Unplug the user panel from the primary AC mains PCMA board.

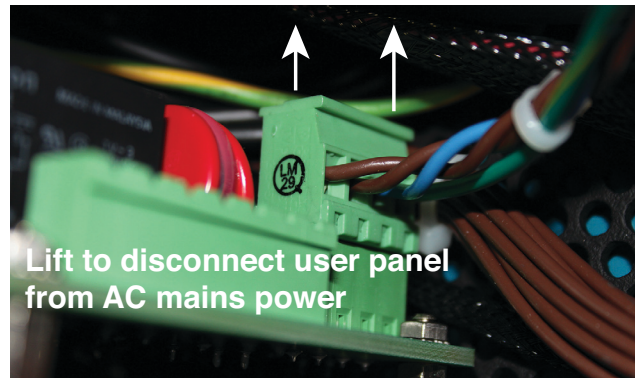

- Disconnect the ribbon cable from the control card.

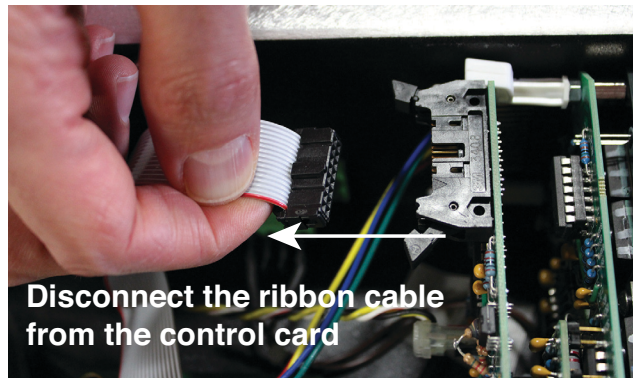

- Remove the ribbon cable from the main PCBA board by releasing the latches on both sides of the connector.

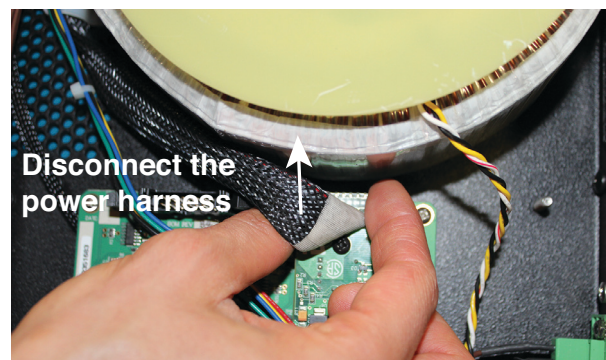
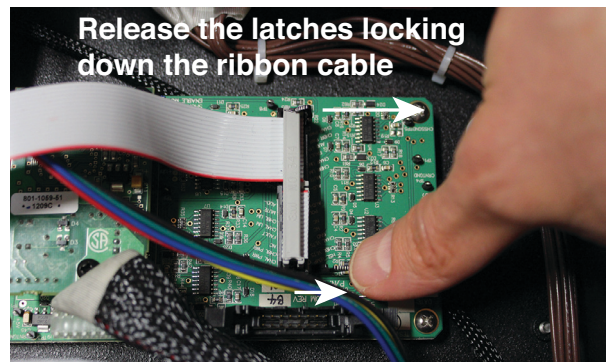



10. Disconnect the power harness from the main RMS PCBA board.

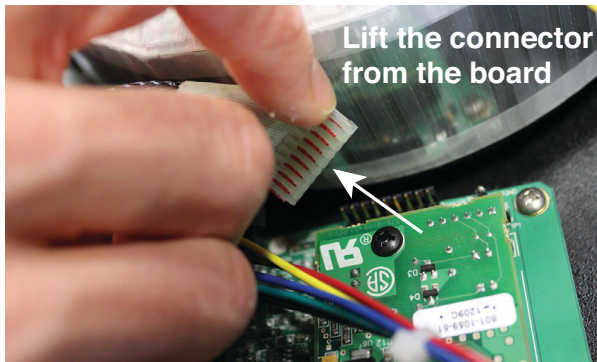
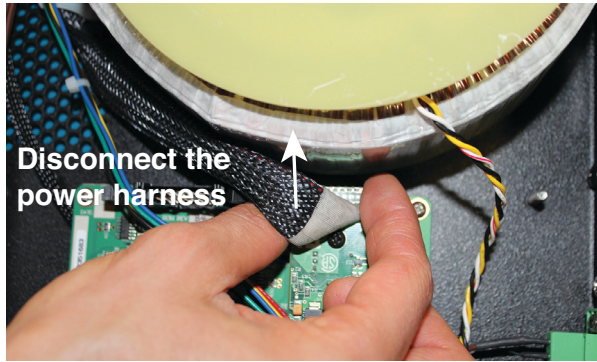

11. Remove four screws to allow the card to be removed from the amplifier chassis.

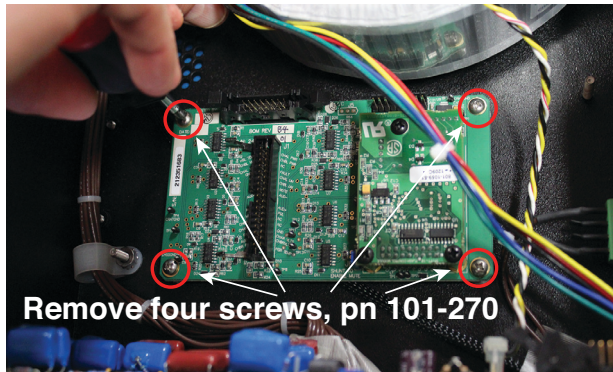

12. The MX RMS module used in LEO-M and the 1100-LFC.

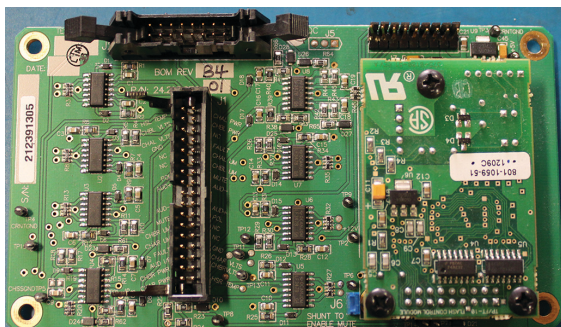

pn 24.215.072.01

## INSTALLING THE MUTE JUMPER ON THE MX RMS MODULE

To use the mute and solo functions of the MX RMS module, the Mute Jumper must be installed on the module. Meyer Sound currently ships RMS-equipped loudspeakers with the Mute Jumper installed. These mute-enabled loudspeakers can be identified by the blue “ME” sticker on the MX RMS user panel. Older RMS-equipped loudspeakers can be easily mute-enabled by installing the Mute Jumper, available from Meyer Sound in a mute jumper kit, P/N 476.005 RMS Mute Enable Replacement Upgrade Jumper.



ME Sticker

To install the Mute Jumper on the MX RMS module:

1. Remove the loudspeaker’s AC power cable and then wait at least five minutes before removing the MX RMS module.
2. On the MX RMS module, locate the two (J3) jumper pins labeled SHORT TO ENABLE MUTE and install the blue Mute Jumper on these two pins.



RMS Mute Jumper

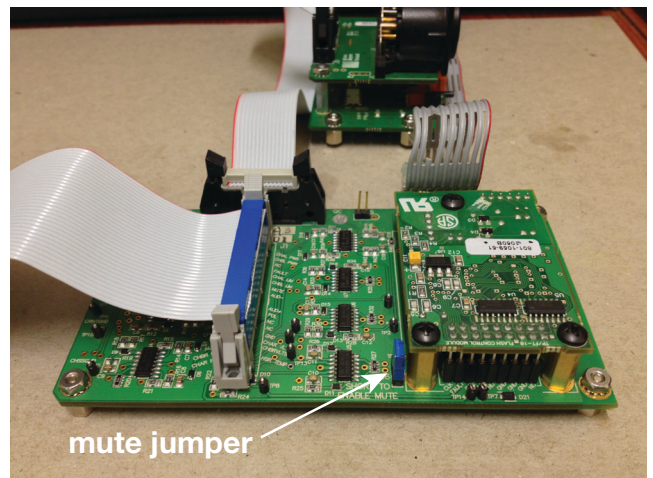

MX RMS Module Jumper Pins

**CAUTION:** Do not mistakenly install the Mute Jumper on the white, unlabeled two-pin connector on the MX RMS module. This connector is for the VEAM connector option; using it for any other purpose will damage the module.

3. Reinstall the MX RMS module in the loudspeaker.

## MX RMS USER PANEL

The MX RMS user panel includes an Identify button, Wink/Activity LED, Remote Mute switch, and two Network connectors.

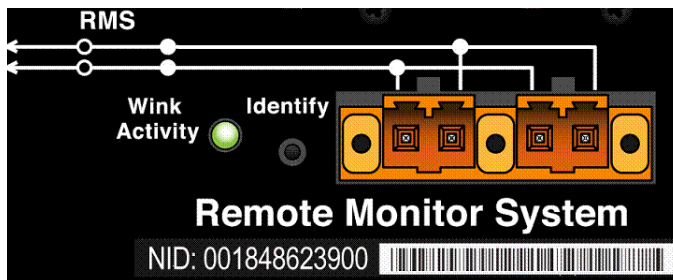

Figure 1: MX RMS module user panel

**NOTE:** The button and LED on the MX RMS user panel are used exclusively by Compass RMS and have no effect on the acoustical or electrical activity of the loudspeaker.

## Identify Button

The Identify button serves the following functions:

- If the loudspeaker has not yet been discovered (Wink/Activity LED not lit), press the Identify button to identify the loudspeaker in the Compass RMS system and discover it.
- To undiscover the loudspeaker and remove it from the RMServer inventory, press and hold the Identify button during startup (see “Resetting the MX RMS Module” on page 46).
- To wink a discovered loudspeaker, press the Identify button. The Wink LED on the loudspeaker icon in Compass lights up and the Wink/Activity LED on the loudspeaker’s RMS user panel turns solid green. Press the Identify button again to unwink the loudspeaker.

**TIP:** The Wink function is useful for identifying the physical loudspeaker corresponding to a loudspeaker icon in Compass.

## Wink/Activity LED (Green)

The green Wink/Activity LED indicates the status of the loudspeaker:

- During startup, the LED blinks 10 times.
- If the loudspeaker has not yet been discovered, the LED is not lit after startup.
- If the loudspeaker has been successfully discovered, the LED flashes continuously and flashes more rapidly with increased data activity.
- When the loudspeaker is winked, either by clicking the Wink button in Compass or by pressing the Identify button on the RMS user panel, the LED is solid green.

**TIP:** The Wink function is useful for identifying the physical loudspeaker corresponding to a loudspeaker icon in Compass.

## RMS Network Connectors

The two Weidmuller connectors transfer data to and from the RMS network. Two connectors are provided to allow for easy connection of multiple (daisy-chained) loudspeakers on the network. Included with each RMS-equipped loudspeaker are RMS cable connectors and mounting blocks for constructing RMS cables. The RMS blocks allow the cables to be securely attached to the RMS module with screws.

## NEURON ID FOR MX RMS MODULES

Each MX RMS module has a unique 12-character Neuron ID (NID) that identifies the loudspeaker on the network. The NID should be discovered automatically by the RMServer to which it is connected, but can be entered manually, if necessary. The NID for the MX RMS module is located on the user panel below the orange RMS Network connectors (see Figure 1 on page 46).

## RESETTING THE MX RMS MODULE

You can use the Identify button to reset the MX RMS module when powering up the loudspeaker. This will cause the module to be reset, and the loudspeaker to be undiscovered and removed from the RMServer inventory.

To reset the MX RMS module:

1. Disconnect the loudspeaker’s power cord.
2. Press and hold the Identify button.
3. While continuing to hold down the Identify button, reconnect the power cord.

4. After the Wink/Status LED blinks on and off, release the Identify button. The MX RMS module is reset and the loudspeaker is undiscovered and removed from the RMServer inventory.





## CHAPTER 8: LYON RMS MODULE

The LYON RMS module is used only in the LYON loudspeaker, in which it comes standard.

When equipped with an RMS module, Meyer Sound loudspeakers can be connected to an RMS network and monitored with Compass control software. Some Meyer Sound loudspeakers, including LYON, come standard with the RMS module already installed. For other Meyer Sound loudspeakers, the RMS module is available as an option that can either be factory installed or installed at a later date by a qualified service technician.

The following sections document how to install and use the LYON RMS module:

- “Installing the LYON RMS Module” on page 49
- “Neuron ID for Lyon RMS Modules” on page 51
- “Resetting the Lyon RMS Module” on page 51

### INSTALLING THE LYON RMS MODULE

This section documents installing the LYON RMS module. This installation procedure requires a standard #2 Phillips screwdriver.

To install the LYON RMS module:

1. Remove the loudspeaker’s AC power cable and audio cable and place the loudspeaker on a clean, low-static flat surface. Orient the loudspeaker with the top facing up. Wait at least five minutes before removing the MX RMS module.
2. Remove the 4 screws that hold the module to the amplifier rear panel.

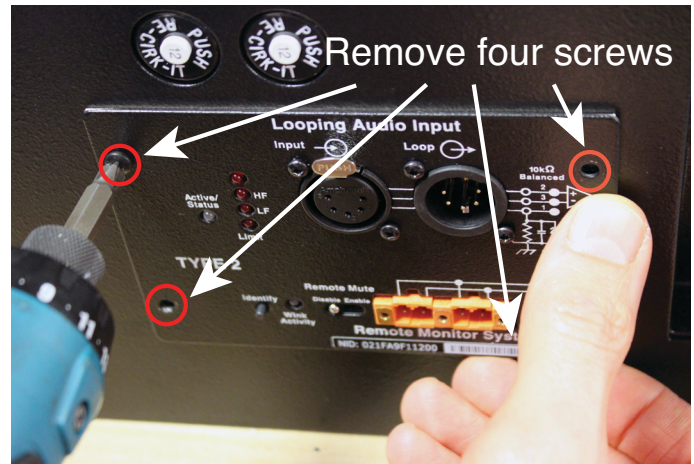

3. Turn the module slightly to the right to allow the RMS interconnect wire to clear the amplifier rear panel.



- Remove the panel completely from the amplifier assembly (there should be enough room to reach the flat cable that connects the module to the digital control card.)

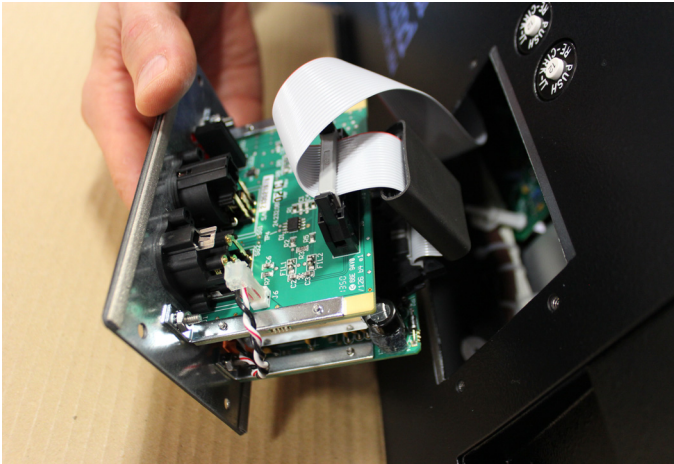

**NOTE:** Make sure to hold the LYON RMS module by its edges. Avoid touching any of the components on the module.

- Remove the flat cable from each circuit board connector on the LYON RMS 4.1 module.

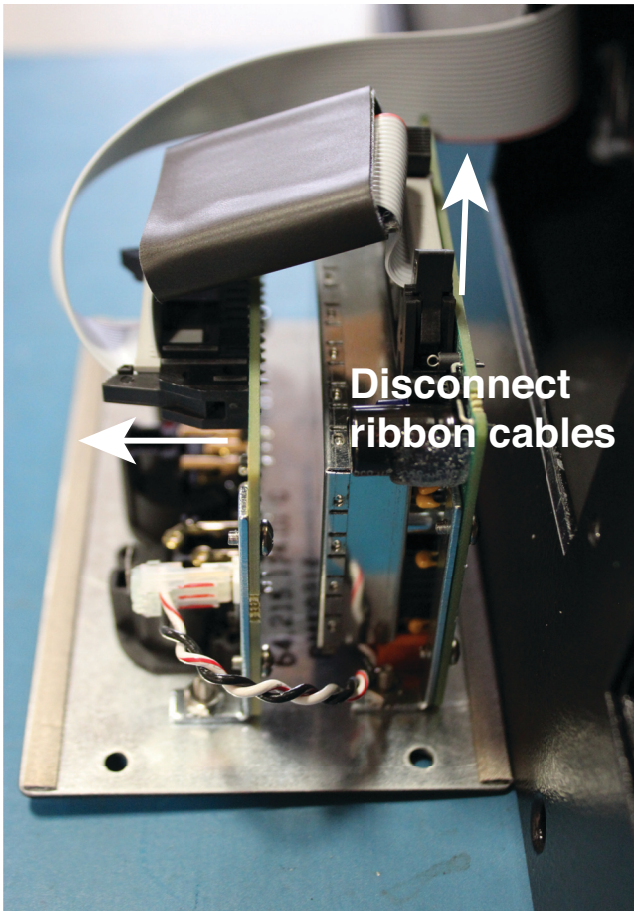

- Install the new LYON RMS 4.1 module....

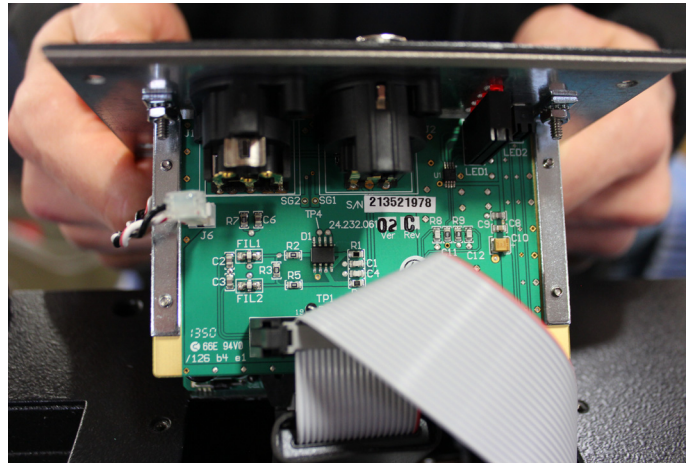

### LYON RMS USER PANEL

The LYON RMS user panel includes an Identify button, Wink/Activity LED, Remote Mute switch, and two Network connectors.

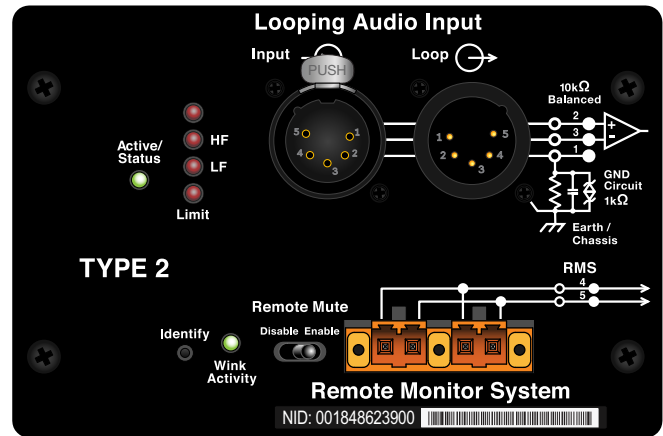

Figure 1: LYON RMS module user panel

**NOTE:** The button and LED on the LYON RMS user panel are used exclusively by Compass RMS and have no effect on the acoustical or electrical activity of the loudspeaker.



## Identify Button

The Identify button serves the following functions:

- If the loudspeaker has not yet been discovered (Wink/Activity LED not lit), press the Identify button to identify the loudspeaker in the Compass RMS system and discover it.
- To undiscover the loudspeaker and remove it from the RMServer inventory, press and hold the Identify button during startup (see “Resetting the Lyon RMS Module” on page 51).
- To wink a discovered loudspeaker, press the Identify button. The Wink LED on the loudspeaker icon in Compass lights up and the Wink/Activity LED on the loudspeaker’s RMS user panel turns solid green. Press the Identify button again to unwink the loudspeaker.



**TIP:** The Wink function is useful for identifying the physical loudspeaker corresponding to a loudspeaker icon in Compass.

## Wink/Activity LED (Green)

The green Wink/Activity LED indicates the status of the loudspeaker:

- During startup, the LED blinks 10 times.
- If the loudspeaker has not yet been discovered, the LED is not lit after startup.
- If the loudspeaker has been successfully discovered, the LED flashes continuously and flashes more rapidly with increased data activity.
- When the loudspeaker is winked, either by clicking the Wink button in Compass or by pressing the Identify button on the RMS user panel, the LED is solid green.



**TIP:** The Wink function is useful for identifying the physical loudspeaker corresponding to a loudspeaker icon in Compass.

## RMS Network Connectors

The two Weidmuller connectors transfer data to and from the RMS network. Two connectors are provided to allow for easy connection of multiple (daisy-chained) loudspeakers on the network. Included with each RMS-equipped loudspeaker are RMS cable connectors and mounting blocks for constructing RMS cables. The RMS blocks allow the cables to be securely attached to the RMS module with screws.

## NEURON ID FOR LYON RMS MODULES

Each LYON RMS module has a unique 12-character Neuron ID (NID) that identifies the loudspeaker on the network. The NID should be discovered automatically by the RMServer to which it is connected, but can be entered manually, if necessary. The NID for the LYON RMS module is located on the user panel below the orange RMS Network connectors (see Figure 1 on page 50).

## RESETTING THE LYON RMS MODULE

You can use the Identify button to reset the LYON RMS module when powering up the loudspeaker. This will cause the module to be reset, and the loudspeaker to be undiscovered and removed from the RMServer inventory.

To reset the LYON RMS module:

1. Disconnect the loudspeaker’s power cord.
2. Press and hold the Identify button.
3. While continuing to hold down the Identify button, reconnect the power cord.

4. After the Wink/Status LED blinks on and off, release the Identify button. The LYON RMS module is reset and the loudspeaker is undiscovered and removed from the RMServer inventory.

## CHAPTER 9: MPS-488HP EXTERNAL POWER SUPPLY WITH RMS

48 V DC loudspeakers can be integrated in RMS networks via the MPS-488HP external power supply (when equipped with the factory-installed RMS option). Up to eight loudspeakers can be connected to the MPS-488HP with their voltage and DC current being monitored in Compass RMS software. Loudspeakers can also be muted and unmuted from the software. Supported loudspeakers include:

- MM-4XP miniature loudspeaker
- MM-4XPD directional miniature loudspeaker
- UP-4XP ultracompact loudspeaker
- UP-4XPV ultracompact loudspeaker
- UPM-1XP ultracompact wide-coverage loudspeaker
- UPJ-1XP compact VariO loudspeaker
- UPJunior-XP ultracompact VariO loudspeaker
- UMS-1XP ultracompact subwoofer
- MM-10XP compact subwoofer
- HMS-5 compact cinema surround loudspeaker
- HMS-10 cinema surround loudspeaker
- HMS-12 high-power cinema surround loudspeaker

This chapter documents using the MPS-488HP in Compass RMS and includes the following topics:

- “MPS-488HP RMS User Panel” on page 53
- “Neuron ID for MPS-488HP RMS Module” on page 54
- “Resetting the MPS-488HP RMS Module” on page 54
- “The MPS-488HP in Compass Software” on page 54

 **NOTE:** The RMS module is only available as a factory-installed option for the MPS-488HP. For more information, contact Meyer Sound Technical Support.

 **NOTE:** Each MPS-488-HP power supply occupies the bandwidth of four normal loudspeakers (four nodes). Bandwidth restrictions dictate a maximum of 12 MPS-488HPs can be connected to a single RMS server.

### MPS-488HP RMS USER PANEL

The MPS-488HP RMS user panel includes an Identify button, Wink/Activity LED, and two Network connectors.

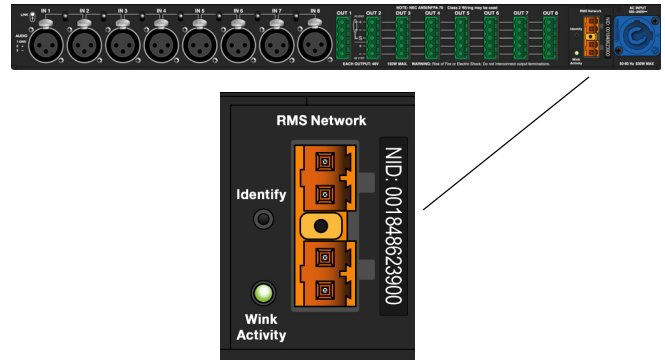



Figure 1: MPS-488HP RMS User Panel

 **NOTE:** The Identify button and Wink/Activity LED on the MPS-488HP RMS user panel are used exclusively by Compass RMS and have no effect on the acoustical or electrical activity of the loudspeakers connected to the MPS-488HP.

### Identify Button

The Identify button serves the following functions:

- If the MPS-488HP has not yet been discovered (Wink/Activity LED not lit), press the Identify button to identify the MPS-488HP on the RMS network and discover it.
- To undiscover the MPS-488HP and remove it from the RMS server inventory, press and hold the Identify button during startup (see “Resetting the MPS-488HP RMS Module” on page 54).
- To *wink* a discovered MPS-488HP, press the Identify button. The Wink LED on the MPS-488HP icon in the Compass software lights up and the Wink/Activity LED on the RMS user panel turns solid green. Press the Identify button again to unwick the MPS-488HP.

 **TIP:** The Wink function is useful for identifying the physical MPS-488HP corresponding to a MPS-488HP icon in the Compass software.

## Wink/Activity LED (Green)

The green Wink/Activity LED indicates the status of the MPS-488HP:

- During startup, the LED blinks 10 times.
- If the MPS-488HP has not yet been discovered, the LED is not lit after startup.
- If the MPS-488HP has been successfully discovered, the LED flashes continuously and flashes more rapidly with increased data activity.
- When the MPS-488HP is winked, either by clicking the Wink button in the RMS software or by pressing the Identify button on the RMS user panel, the LED is solid green.

## RMS Network Connectors

The two Weidmuller connectors transfer data to and from the RMS network. Two connectors are provided to allow for easy connection of the MPS-488HP to the RMS network. Included with each RMS-equipped MPS-488HP are RMS cable connectors and mounting blocks for constructing RMS cables. The RMS blocks allow the cables to be securely attached to the RMS module with screws.

## NEURON ID FOR MPS-488HP RMS MODULE

Each MPS-488HP RMS module has a unique 12-character Neuron ID (NID) that identifies the MPS-488HP on the network. The NID should be discovered automatically by the RMServer to which the MPS-488HP is attached, but it can be entered manually, if necessary. The NID for the MPS-488HP RMS module is located on the rear user panel to the right of the orange RMS network connectors (see Figure 1 on page 53).

## RESETTING THE MPS-488HP RMS MODULE

You can use the Identify button to reset the MPS-488HP RMS module when powering up the unit. This will cause the MPS-488HP to be undiscovered and removed from the RMServer inventory.

To reset the MPS-488HP RMS module:

1. Turn off the MPS-488HP by pressing its power switch.
2. Press and hold the Identify button.
3. While continuing to hold down the Identify button, turn on the MPS-488HP.

4. After the Wink/Status LED blinks on and off, release the Identify button. The MPS-488HP RMS module is reset and the unit is undiscovered and removed from the RMServer inventory.

## THE MPS-488HP IN COMPASS SOFTWARE

The MPS-488HP appears and functions in the RMS tab of Compass software in the same manner as do loudspeakers. For the MPS-488HP to be recognized and identified by an RMServer, it must be powered on and connected to the network. The MPS-488HP is added to the network as a single node, regardless of the number of loudspeakers attached to it.



**NOTE:** Each MPS-488HP consumes four of the maximum 50 nodes a single RMServer can service, while a standard, mains-powered loudspeaker consumes only one node. A single RMServer could, for example, service 10 MPS-488HPs (40 nodes) plus 10 mains-powered loudspeakers.

All configuration and monitoring activity beyond physical connections takes place in the RMS tab of Compass, including:

- Assigning a user-chosen name to an MPS-488HP
- Editing the product type and name of each loudspeaker connected to an MPS-488HP
- Appearance and functionality of the MPS-488HP on user pages
- Muting and soloing channels of an MPS-488HP
- Editing the loudspeaker ID of an MPS-488HP.
- Monitoring power supply voltages for the loudspeakers attached to an MPS-488HP

For more information on using the MPS-488HP in Compass control software, see [www.meversound.com](http://www.meversound.com).

## APPENDIX A: COMPARISON OF RMS MODULES

Table 3 documents the differences between the RMS modules. Loudspeakers with asterisks (\*) come standard with the RMS module.

**Table 3: RMS Module**

RMS Module	LEDs	Buttons	RMS Network Connectors	Mute Enable
<p>HP/MP (PN 40.033.071.01) (Acheron 100, Acheron 80, Acheron LF, 600-HP, 700-HP, 650-P, DF-4, DS-2P, DS-4P, M2D-Sub*, M3D*, M3D-Sub*, MICA*, MILO 60*, MILO 120*, MSL-4, MSL-6, MTS-4, PSM-2, PSW-2, PSW-4, PSW-6, SB-1, SB-2, SB-3F)</p>	<p>Service LED (Red):</p> <ul style="list-style-type: none"> <li>■ Blinks once every 2 seconds if the loudspeaker is connected to network and not yet discovered.</li> <li>■ Lights solid when the loudspeaker encounters an RMS hardware failure.</li> </ul> <p>Wink LED (Green):</p> <ul style="list-style-type: none"> <li>■ Lights solid when the loudspeaker is winked from the RMS program.</li> </ul> <p>Activity LED (Green):</p> <ul style="list-style-type: none"> <li>■ Flashes continuously when the loudspeaker is discovered.</li> </ul>	<p>Service Button:</p> <ul style="list-style-type: none"> <li>■ Press to identify the loudspeaker on the RMS network during the discovery process.</li> <li>■ Press and hold with the Reset button to reset and undiscover the loudspeaker.</li> </ul> <p>Reset Button:</p> <ul style="list-style-type: none"> <li>■ Press to reboot the RMS firmware without discovering the loudspeaker.</li> <li>■ Press and hold with the Service button to reset and undiscover the loudspeaker.</li> </ul>	2 Weidmuller connectors	Jumper (pins J3)
<p>UltraSeries UX (PN 40.084.008.01) (500-HP, JM-1P, M1D, M1D-Sub*, M'elodie*, MJF-212, MJF-212A, UMS-1P, UPJ-1P, UPJunior, UPM-1P, UPM-2P, UPQ-1P, UPQ-2P)</p> <p>UltraSeries UPM (PN 40.076.028.01) (Acheron Studio, M2D*, UPA-1P, UPA-2P, UM-1P, UM-100P, USM-1P, USM-100P, USW-1P)</p>	<p>Service LED (Red):</p> <ul style="list-style-type: none"> <li>■ Blinks once every 2 seconds if the loudspeaker is connected to network and not yet discovered.</li> <li>■ Lights solid when the loudspeaker encounters an RMS hardware failure.</li> </ul> <p>Wink LED (Green):</p> <ul style="list-style-type: none"> <li>■ Lights solid when the loudspeaker is winked from the RMS program.</li> </ul> <p>Activity LED (Green):</p> <ul style="list-style-type: none"> <li>■ Flashes continuously when the loudspeaker is discovered.</li> </ul>	<p>Service Button:</p> <ul style="list-style-type: none"> <li>■ Press to identify the loudspeaker on the RMS network during the discovery process.</li> <li>■ Press and hold with the Reset button to reset and undiscover the loudspeaker.</li> </ul> <p>Reset Button:</p> <ul style="list-style-type: none"> <li>■ Press to reboot the RMS firmware without discovering the loudspeaker.</li> <li>■ Press and hold with the Service button to reset and undiscover the loudspeaker.</li> </ul>	2 Weidmuller connectors	Jumper (pins J3)
<p>DX (Acheron Designer, MINA*, X-400C, MJF210*)</p>	<p>Wink/Activity LED (Green):</p> <ul style="list-style-type: none"> <li>■ Blinks 10 ten times when powering up the loudspeaker.</li> <li>■ Unlit, after powering up, if the loudspeaker is not discovered.</li> <li>■ Flashes continuously when the loudspeaker is discovered, and flashes more rapidly with increased data activity.</li> </ul>	<p>Identify Button:</p> <ul style="list-style-type: none"> <li>■ Press to identify the loudspeaker when discovering.</li> <li>■ Press to wink the discovered loudspeaker.</li> <li>■ Press and hold when powering up the loudspeaker to undiscover it.</li> </ul>	2 Weidmuller connectors	Recessed switch on RMS user panel
<p>MX (LEO-M*, 1100-LFC*, LYON)*</p>	<p>Wink/Activity LED (Green):</p> <ul style="list-style-type: none"> <li>■ Blinks 10 ten times when powering up the loudspeaker.</li> <li>■ Unlit, after powering up, if the loudspeaker is not discovered.</li> <li>■ Flashes continuously when the loudspeaker is discovered, and flashes more rapidly with increased data activity.</li> </ul>	<p>Identify Button:</p> <ul style="list-style-type: none"> <li>■ Press to identify the loudspeaker when discovering.</li> <li>■ Press to wink the discovered loudspeaker.</li> <li>■ Press and hold when powering up the loudspeaker to undiscover it.</li> </ul>	2 Weidmuller connectors	Jumper (pins J3)

**Table 3: RMS Module**

RMS Module	LEDs	Buttons	RMS Network Connectors	Mute Enable
<p>MPS-488HP (HMS-5, HMS-10, HMS-12, MM-4XP, MM-4XPD, MM-XPV, MM-10XP, UP-4XP, UPM-1XP, UPJ-1XP, UPJunior-XP, UMS-1XP)</p>	<p>Wink/Activity LED (Green):</p> <ul style="list-style-type: none"> <li>■ Blinks 10 ten times when powering up the loudspeaker.</li> <li>■ Unlit, after powering up, if the loudspeaker is not discovered.</li> <li>■ Flashes continuously when the loudspeaker is discovered, and flashes more rapidly with increased data activity.</li> </ul>	<p>Identify Button:</p> <ul style="list-style-type: none"> <li>■ Press to identify the MPS-488HP on the RMS network during the discovery process.</li> <li>■ Press to wink the discovered MPS-488HP.</li> <li>■ Press and hold when powering up the MPS-488HP to undiscover it.</li> </ul>	<p>2 Weidmuller connectors</p>	<p>None (Always Enabled)</p>



## APPENDIX B: TROUBLESHOOTING RMS PROBLEMS

### Verifying your Computer's IPv4 Address

#### Windows

To verify your computer's IPv4 address in Windows:

1. From the Windows taskbar, click **Start** and type "cmd" in the search field, then press **Enter**.
2. In the Command window, type "ipconfig" and press **Enter**. The computer's IPv4 address, subnet mask, and default gateway are returned.

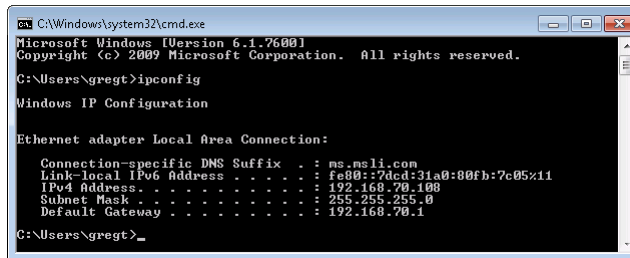

```
C:\Windows\system32\cmd.exe
Microsoft Windows [Version 6.1.7600]
Copyright (c) 2009 Microsoft Corporation. All rights reserved.

C:\Users\gregt>ipconfig

Windows IP Configuration

Ethernet adapter Local Area Connection:

    Connection-specific DNS Suffix  . : ms.mali.com
    Link-local IPv6 Address . . . . . : fe80::7dcd:31a0:80fb:7e05%11
    IPv4 Address. . . . . : 192.168.70.108
    Subnet Mask . . . . . : 255.255.255.0
    Default Gateway . . . . . : 192.168.70.1

C:\Users\gregt>
```

3. If the computer's IPv4 address range does not match the RMServer's and you want to change the address for the computer, do the following:

- From the Windows taskbar, choose **Start > Control Panel**.
- In the Control Panel window, open the **Network and Sharing Center** control panel and then click **Local Area Connection**.
- In the Local Area Connection Status dialog box, click **Properties**.

- In the Local Area Connection Properties dialog box, select **Internet Protocol Version 4 (TCP/IPv4)** and click **Properties**.

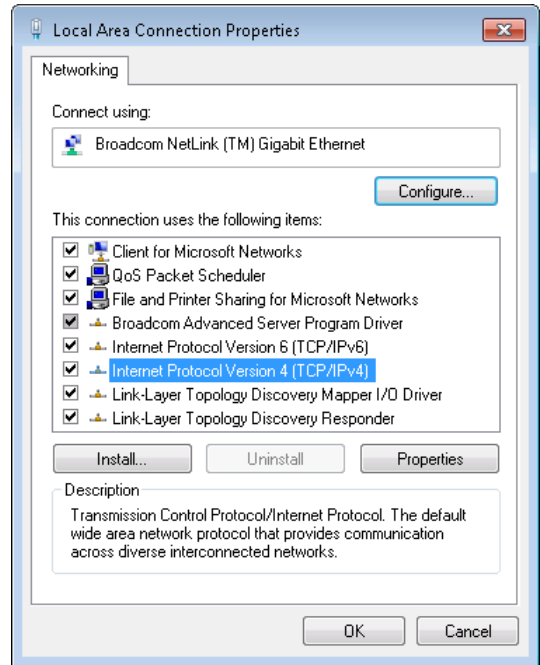

- In the Internet Protocol Version 4 (TCP/IPv4) Properties dialog box, select "Use the Following IP Address" and enter 192.168.0.100 in the **IP Address** field. Click in the Subnet Mask field and accept the default values. Click **OK**.

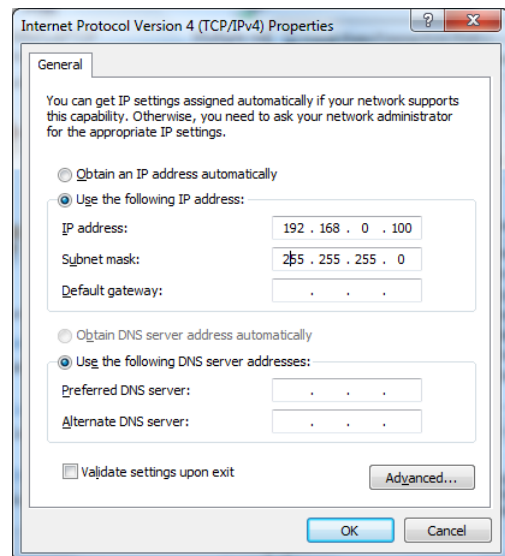

## Mac OS X

To verify your computer's IPv4 address in Mac OS X:

1. From the Apple menu, choose System Preferences.
2. Click the Network control panel to open it.
3. Click the currently active Ethernet connection in the left column. The IPv4 address will be displayed.

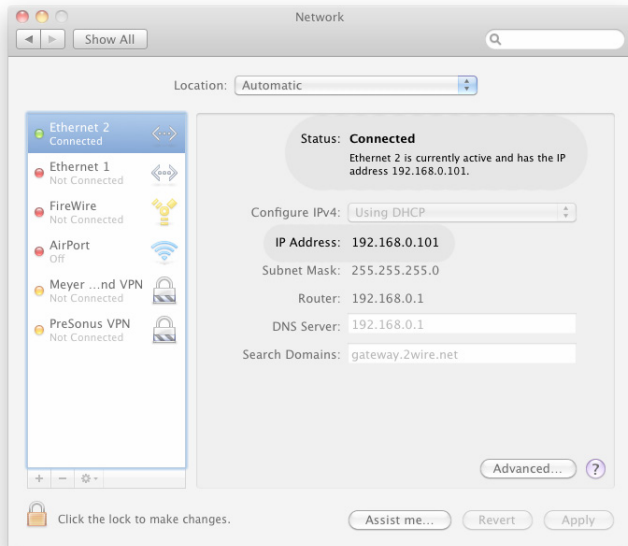

## Verifying RMServer's IPv4 Address

To verify RMServer's IPv4 address:

1. Access the RMServer web server from your browser as described in the section "Configuring the RMServer Web Server" on page 12.
2. Click the Dashboard tab. The IPv4 address will be displayed in the IP Address field of the Host and Network Information area.

## Using the Ping Command

The Ping command can be used to verify the connection between the Compass RMS host computer and the network hardware. The Ping command also measures the speed of the response times.

## Windows

To use the Ping command in Windows:

1. From the Windows taskbar, click **Start** and type "cmd" in the search field, then press **Enter**.
2. In the Command window, type the following and press **Enter**.

```
ping [IP address]
```

The Ping command is sent. Below are some of the more common results that may be encountered.

- The following example illustrates when the Ping command is returned successfully. The time for the Ping is indicated in milliseconds. Long return times can be caused by network congestion.

```
C:\Windows\system32\ping.exe
Pinging 192.168.1.102 with 32 bytes of data:
Reply from 192.168.1.102: bytes=32 time=8ms TTL=30
Reply from 192.168.1.102: bytes=32 time=4ms TTL=30
Reply from 192.168.1.102: bytes=32 time=4ms TTL=30
Reply from 192.168.1.102: bytes=32 time=4ms TTL=30
Ping statistics for 192.168.1.102:
    Packets: Sent = 4, Received = 4, Lost = 0 (0% loss),
    Approximate round trip times in milli-seconds:
        Minimum = 4ms, Maximum = 8ms, Average = 5ms
```

- The following example illustrates when the Ping command cannot reach its intended address, usually indicating an incorrect IPv4 address or a bad network connection.

```

C:\Windows\system32\cmd.exe
Microsoft Windows [Version 6.1.7601]
Copyright (c) 2009 Microsoft Corporation. All rights reserved.

C:\Users\Owner>ping 192.168.0.120

Pinging 192.168.0.120 with 32 bytes of data:
Reply from 192.168.0.101: Destination host unreachable.
Reply from 192.168.0.101: Destination host unreachable.
Reply from 192.168.0.101: Destination host unreachable.
Reply from 192.168.0.101: Destination host unreachable.

Ping statistics for 192.168.0.120:
    Packets: Sent = 4, Received = 0, Lost = 0 (0% loss),
C:\Users\Owner>

```

- The following example illustrates when the Ping command is not returned in the allowed time. Ping timeouts generally indicate a problem with the network, such that the network hardware is incorrectly configured, not powered on, or not connected.

```

Command Prompt
Microsoft Windows [Version 6.1.7601]
Copyright (c) 2009 Microsoft Corporation. All rights reserved.

C:\Users\Owner>ping 192.168.0.120

Pinging 192.168.0.120 with 32 bytes of data:
Request timed out.
Request timed out.
Request timed out.
Request timed out.

Ping statistics for 192.168.0.120:
    Packets: Sent = 4, Received = 0, Lost = 4 (100% loss),
C:\Users\Owner>

```

## Mac OS X

To use the Ping command in Mac OS X:

1. Locate and double-click Network Utility.app in the Applications>Utilities folder to launch it.
2. Click the Ping tab at the top of the window.
3. Enter an IPv4 address or URL (DNS name) in the network address field.
4. Set the number of pings as desired.
5. Click the Ping button. Ping messages will be sent.
6. If you selected “Send an unlimited number of Pings,” click the Stop button to stop sending pings.

- The following example illustrates when the Ping command is returned successfully. The time for the Ping is indicated in milliseconds. Long return times can be caused by network congestion.

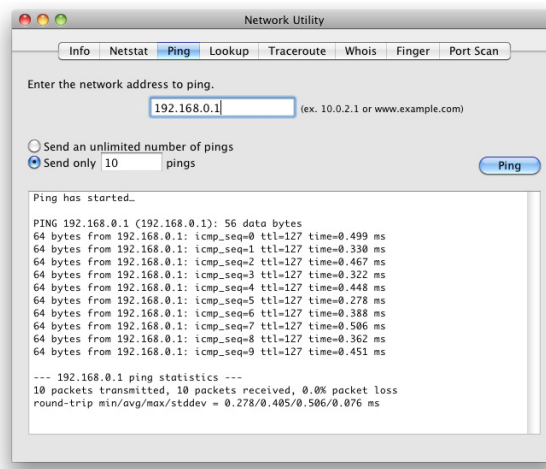

- The following example illustrates when the Ping command cannot reach its intended address, usually indicating an incorrect IPv4 address or a bad network connection.

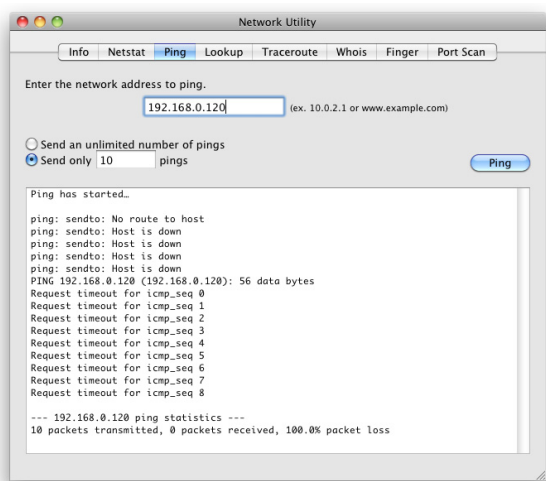

- The following example illustrates when the Ping command is not returned in the allowed time. Ping timeouts generally indicate a problem with the network, such that the network hardware is incorrectly configured, not powered on, or not connected.

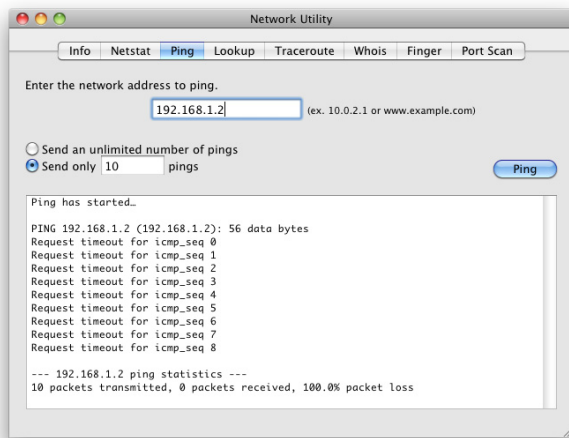

For more information on the Ping command, open the Terminal application, type “man ping,” and press Enter.

## APPENDIX C: EXTERNAL MUTING AND EXTERNAL WARNING RELAYS

To ensure safety at venues with high-level sound reinforcement, some venues require automatic muting of audio systems when a fire alarm or other emergency signal is triggered. RMServer can be configured for external muting of RMS-equipped devices when a fire alarm or external relay is triggered.

This appendix documents using RMServer for externally triggered muting and triggering of RMServer's onboard warning relays. It includes the following topics:

- “Wiring RMServer for External Muting and External Warning Relays” on page 62
- “Configuring External Muting in the RMServer Web server” on page 63
- “Configuring Warning Relays in the RMServer Web Server” on page 64
- “Email Notification for Externally Triggered Muting and Warning Relays” on page 65

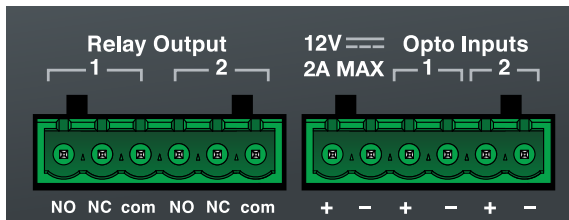

Figure 1: RMServer rear-panel relay connections

## WIRING RMSERVER FOR EXTERNAL MUTING AND EXTERNAL WARNING RELAYS

To enable muting of loudspeakers from a fire alarm or relay contact, RMServer should be wired as follows:

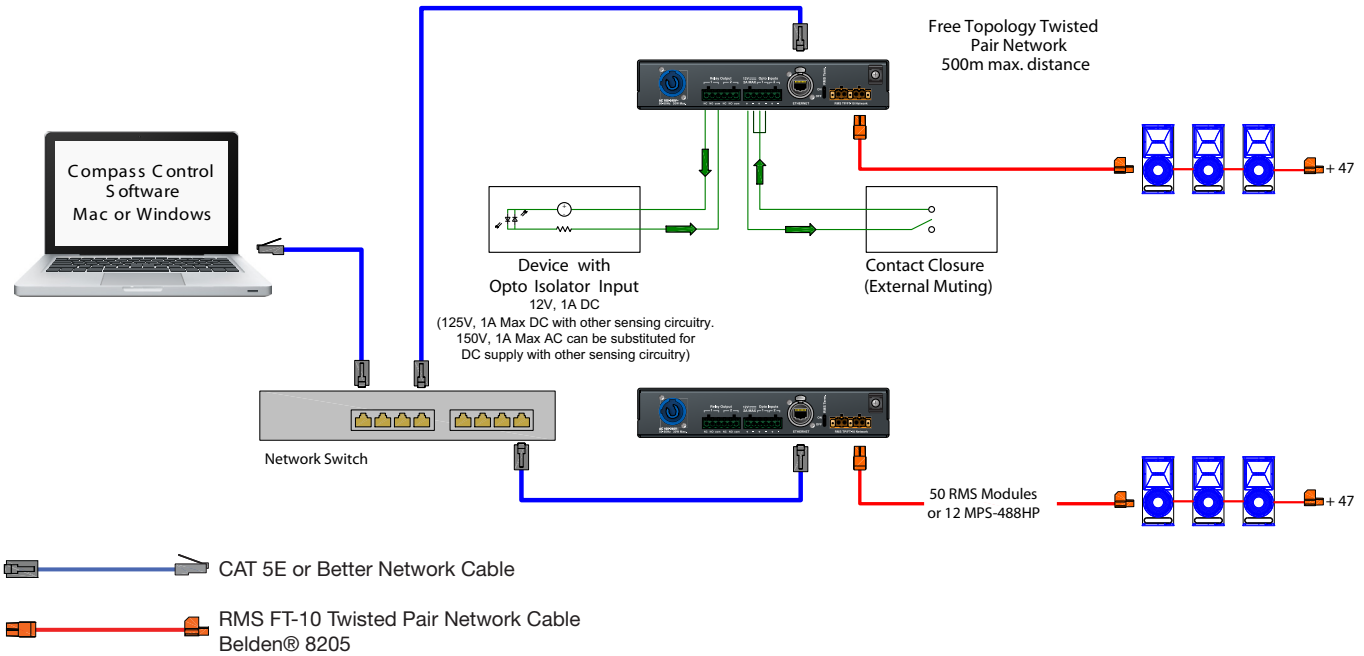

Figure 2: Connection diagram for relay operation of RMServer with external systems for fire alarm muting.

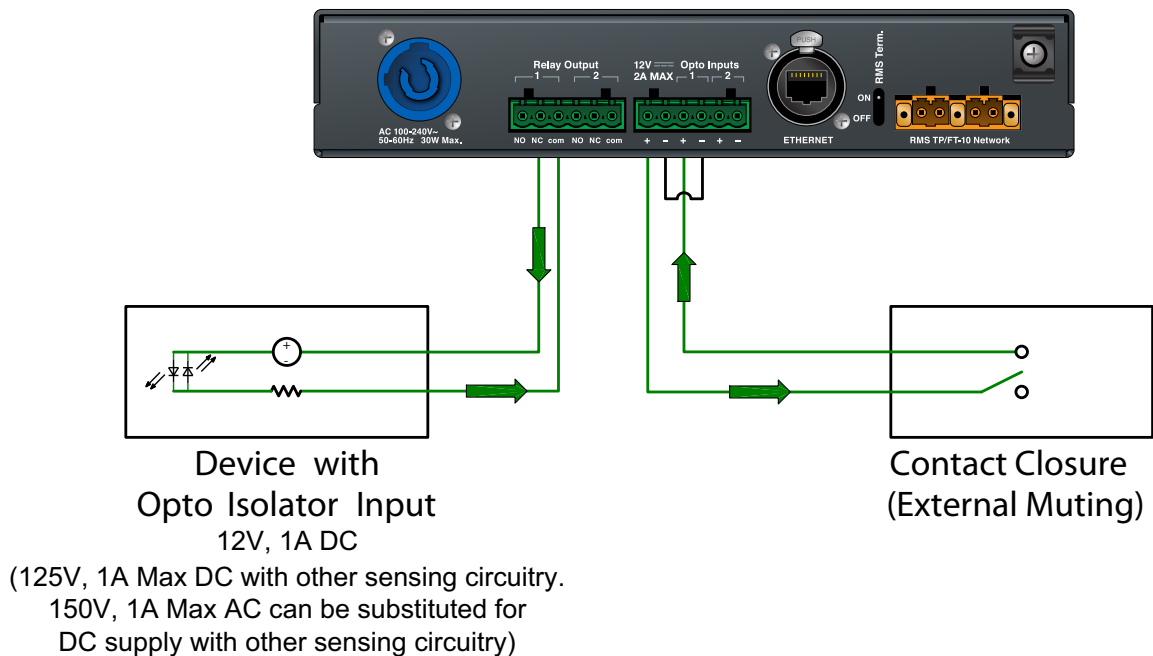

Figure 3: Logic input detail from Figure 2.



## Using the Onboard Relays

1. Connect the COM pin on the Relay 1 or Relay 2 output to an appropriate external opto-isolated input.
2. Connect either the NC pin (for "normally closed" operation) or NO pin (for "normally open" operation) to an appropriate external opto-isolated input. It is assumed that the external input will supply the required voltage for the relay to switch.
3. Configure relay operation on the Basic Settings page of RMServer's web server. For more information on configuring onboard relay operation, see the section "Configuring Warning Relays in the RMServer Web Server" on page 64 and the section "Basic Settings" on page 14.
4. Test relay setups as desired using the test facility on the Advanced Settings page.

## Using External Relays

1. Connect the + (plus sign) pin of the +12 V output to the + pin of Input 1 and/or Input 2 of RMServer.
2. Connect the – (minus sign) pin of the +12 V output to the external relay(s).
3. Connect the other side of the external relay(s) to the – pins of Input 1 and/or Input 2.
4. Enable or disable loudspeaker muting for the inputs on the Basic Settings page of RMServer's web server. For more information on configuring input operation, see the section "Configuring External Muting in the RMServer Web server" on page 63 and the section "Basic Settings" on page 14.

When the relay is open, the RMS network operates normally with the loudspeakers outputting audio. When the relay is closed by a triggering event, a mute command is sent to all loudspeakers on the RMS network. When the relay is reopened, the loudspeakers are unmuted.



**NOTE:** To respond to muting commands from RMS-equipped, loudspeakers must have muting enabled.

## CONFIGURING EXTERNAL MUTING IN THE RMSERVER WEB SERVER

Compass RMS can be configured to automatically mute all loudspeakers when an external relay closure is detected by an RMServer.



**NOTE:** RMServer must be discovered by the Compass control software before it can be used for external muting. Once RMServer has been discovered, Compass software must be running for mute functions to operate.

To enable externally triggered muting by RMServer:

1. Access RMServer's web server page as described in "Accessing the RMServer Web Server" on page 12.
2. On the Basic Settings tab, check the **Enable External Muting on opto input 1** box in the Opto Inputs 1 and 2 section to enable muting triggered by an external relay connected to Opto input 1 on RMServer's back panel, and/or the **Enable External Muting on opto input 2** box to enable muting triggered by an external relay connected to Opto input 2.

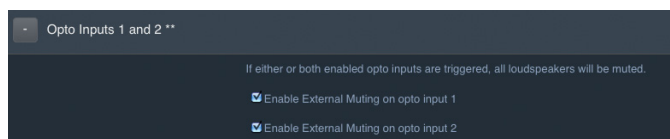

Figure 4: Enable External Muting settings in the Opto Inputs section of the Basic Settings page of RMServer's web server.

3. Click the **Save** button below the checkboxes to save the changes.
4. When the Changes Saved dialog appears, click the **Restart Now** button to restart RMServer. Restarting takes about 30 seconds to complete.



**NOTE:** The RMServer web server may not return to the login page when restarting is complete. If you do not see the login page by 30 seconds after initiating restart, access the web server again from your browser and it will appear (assuming restarting is completed).

## CONFIGURING WARNING RELAYS IN THE RMSERVER WEB SERVER

RMServer contains two relays that can be set to trigger when specified failure conditions occur. failsafe conditions also can be specified which, when met, cause the relays to be reset. These relays are connected to external devices to trigger appropriate actions in those devices.

 **NOTE:** RMServer must be discovered by the Compass control software before it can be used for warning relays. Once RMServer has been discovered, Compass software must be running for warning relay functions to operate.

To enable and configure RMServer's warning relays:

1. Access RMServer's web server page as described in "Accessing the RMServer Web Server" on page 12.
2. On the Basic Settings tab, the Relay Configuration section displays the currently enabled failure conditions for each relay which will trigger it to change state.

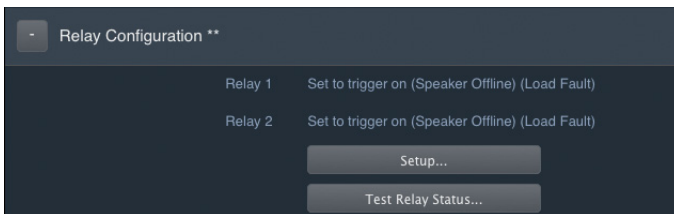

Figure 5: Relay Configuration section of the Basic Settings page of RMServer's web server.

3. To change the conditions specified for one or both relays, click the **Setup** button in the Relay Configuration section to open the Edit Relay Setup dialog.

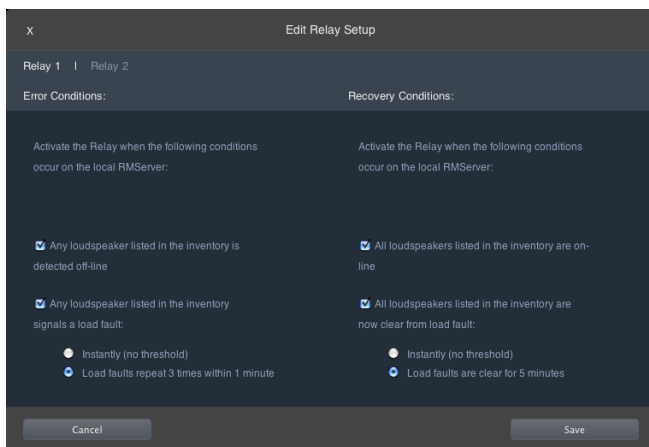



Figure 6: The Edit Relay setup dialog of RMServer's web server.

4. Click the Relay 1 or Relay 2 legend at the top of the dialog to select the relay you want to reconfigure.
5. There are two failure conditions that RMServer can detect:
  - A loudspeaker in the inventory goes off-line.
  - A loudspeaker in the inventory signals a load fault.
6. In the Error Conditions section of the Edit Relay Setup dialog, click the **Any loudspeaker listed in the inventory is detected off-line** box and/or the **Any loudspeaker in the inventory signals a load fault** box to activate one or both failure conditions for the selected relay.
7. If the **Any loudspeaker in the inventory signals a load fault** box is checked, then check the **Instantly (no threshold)** box to trigger the relay as soon as any load fault is detected, or the **Load faults repeat 3 times within 1 minute** box to trigger the relay only after repeated faults are detected.
8. If desired, click the legend at the top of the dialog for the other relay and configure its failure conditions.
9. In the Recovery Conditions section of the Edit Relay Setup dialog, click the **All loudspeakers listed in the inventory are on-line** box and/or the **All loudspeakers in the inventory are now clear from load fault** box to activate one or both conditions that signal restoration of proper operation and trigger resetting of the selected relay to its default state.
10. If the **All loudspeaker in the inventory are now clear from load fault** box is checked, then check the **Instantly (no threshold)** box to reset the relay as soon as all load faults are cleared, or the **Load faults are clear for 5 minutes** box to reset the relay only after no faults have occurred in the five minutes following clearing of the fault condition
11. If desired, click the legend at the top of the dialog for the other relay and configure its recovery conditions.
12. Click the **Save** button in the lower right corner of the dialog to save the changes.
13. When the Changes Saved dialog appears, click the **Restart Now** button to restart RMServer. Restarting takes about 30 seconds to complete.

 **NOTE:** The RMServer web server may not return to the login page when restarting is complete. If you do not see the login page by 30 seconds after initiating restart, access the web server again from your browser and it will appear (assuming restarting is completed).

## EMAIL NOTIFICATION FOR EXTERNALLY TRIGGERED MUTING AND WARNING RELAYS

Compass RMS supports email notification for external muting and external warning relays.

To configure email notifications:

1. Access RMServer's web server page as described in "Accessing the RMServer Web Server" on page 12.
2. On the Basic Settings tab, the Email Notification section displays the currently specified destination email addresses for notifications.

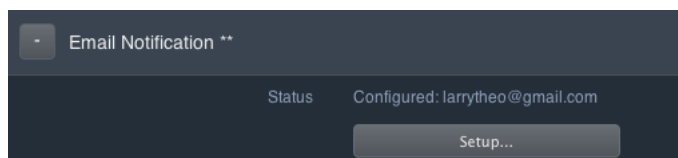

Figure 7: Email Notification section of the Basic Settings page of RMServer's web server.

3. To setup or change the events that trigger email notifications and the email server and address configurations, click the **Setup** button in the Email Notification section to open the Edit Email Notification dialog.
4. In the Edit Email Notification dialog, enter one or more destination email addresses in the **Send To:** field. Email addresses should be separated by commas.
5. Enter your email server information in the **SMTP Server** section of the dialog. Check the **SMTP Server Requires Authentication** box to enable the **Encryption Type**, **Username**, and **Password** fields.
6. Click the **Send Test Email** button at the bottom of the dialog to verify the connection to your email server. If necessary, contact your system administrator to resolve any issues.

7. Check the **When external muting is triggered** and/or the **When external relays are triggered** boxes to specify the events that will trigger email notifications.

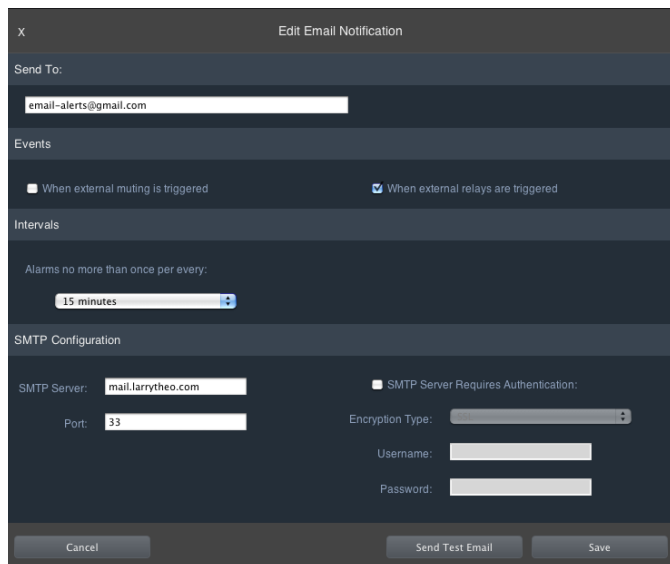

Figure 8: Edit Email Notification dialog of RMServer's web server.

8. Choose a minimum interval for email notifications from the **Alarms no more than once every** drop-down menu in the Intervals section of the dialog.
9. Click **Save** to close the Edit Email Notification dialog and save your changes.
10. When the Changes Saved dialog appears, click the **Restart Now** button to restart RMServer. Restarting takes about 30 seconds to complete.



**NOTE:** The RMServer web server may not return to the login page when restarting is complete. If you do not see the login page by 30 seconds after initiating restart, access the web server again from your browser and it will appear (assuming restarting is completed).



## APPENDIX D: FTR-120 FREE TOPOLOGY REPEATER

This chapter documents the FTR-120 Free Topology Repeater and includes the following topics:

- “About the FTR-120” on page 67
- “Installing and Using the FTR-120” on page 67

### ABOUT THE FTR-120

The FTR-120 is a four-channel network repeater. A message generated on any network segment to which the FTR-120 is connected is rebroadcasted on the three other channels.

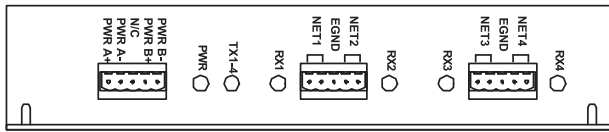

FTR-120 Free Topology Repeater

There are six status LEDs on the unit:

- The PWR LED is the power indicator. It is lit if power is properly supplied to the unit.
- The other five LEDs indicate the amount of network traffic. The TX1-4 LED flashes when a message is transmitted by the repeater. The RX1, RX2, RX3, RX4 LEDs flash when a message is received on a particular channel.

For example, if a message is received on channel 1, the RX1 LED flashes, the message is transmitted on the other channels (2, 3, and 4), and the TX1-4 LED flashes.

 **NOTE:** See Chapter 3, “Connecting RMS Networks” for configurations using the FTR-120 network repeater.

## INSTALLING AND USING THE FTR-120

### FTR-120 Physical Installation

The FTR-120 can be mounted on a wall or other surface using four #6 wood screws (or equivalent). It can be mounted horizontally with the terminal blocks facing down, or vertically with the terminal blocks on the right side. The FTR-120 unit and associated wiring should be mounted and fastened securely, so that no stress is incurred. Do not install the FTR-120 in a manner that would allow unanticipated disconnection.

### FTR-120 Network Terminations

The FTR-120 is capable of providing standard network termination. As shipped, each channel on the unit has 5-ohm network termination resistors connected. If no termination or 100-ohm network termination is required, the chassis lid must be removed.

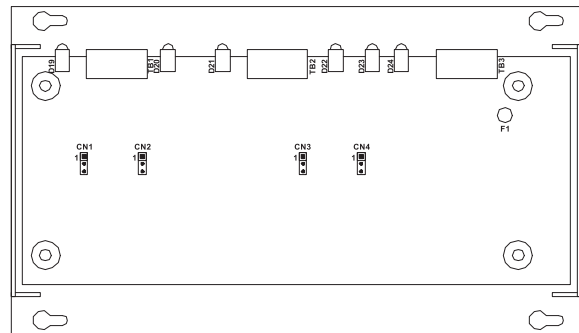

FTR-120 Jumper Layout

Network termination can be changed by moving the shorting jumper on CN1, CN2, CN3, or CN4. Table 4 describes the jumper positions.

**Table 4: FTR-120 Jumper Settings**

Channel Number	No Termination	5-ohm Termination	100-ohm Termination
CN1	No Jumper	Jump 1 and 2	Jump 2 and 3
CN2	No Jumper	Jump 1 and 2	Jump 2 and 3
CN3	No Jumper	Jump 1 and 2	Jump 2 and 3
CN4	No Jumper	Jump 1 and 2	Jump 2 and 3

When installing an FTR-120 network repeater on a Com-pass-based RMS network, avoid using the twisted wire terminator (provided in the RMS peripheral kit) on the network output of the loudspeakers connected to the repeater unless the repeater terminator is removed. Double terminating any network output will decrease performance.

### FTR-120 Wiring

The FTR-120 is wired using five position terminal blocks. The wiring pin-out for the FTR-120 module is shown in Table 5.

**Table 5: FTR-120 Wiring Pin-Out**

Pin Description	Function
PWR A+	Power A+ positive supply connection
PWR A-	Power A- negative supply connection
N/C	No connection (reserved)
PWR B+	Power B+ positive supply connection
PWR B-	Power B- negative supply connection
NET1	Network channel 1 connection
NET1	Network channel 1 connection
EGND	Earth ground
N/C	No connection (reserved)
NET2	Network channel 2 connection
NET2	Network channel 2 connection
NET3	Network channel 3 connection
NET3	Network channel 3 connection
EGND	Earth ground
N/C	No connection (reserved)
NET4	Network channel 4 connection
NET4	Network channel 4 connection

Power A+ and Power A- are the power supply inputs. Connect the positive lead of the power supply to the terminal block Power A+ and the negative lead of the power supply to the terminal block Power A-.

If a redundant supply is required, connect it to Power B+ and Power B-. Connect the positive lead of the redundant power supply to the terminal block Power B+ and the negative lead of the power supply to the terminal block Power B-.

Network 1-4 are the network connections. Network 1 is the channel 1 network connection. Connect the first network twisted pair to the terminal block NET1 positions. The wiring is polarity-independent so it does not matter which wire in the pair is connected to which position on the terminal block. Connect the rest of the network twisted pairs to the other channels. Leave any unused channels unconnected.



**NOTE:** Terminals labeled EGND should be connected to an earth ground.

### The FTR-120 Universal Power Supply

The universal power supply included with the repeater kit allows for FTR-120 operation around the world. The male IEC input allows for any mains lead adapter to be used with the supply.

**Table 6: FTR-120 Power Supply Specifications**

Input Voltage	100 V AC to 240 V AC
Output Voltage	+12 V DC to +24 V DC +/-10% @ 100 mA







- 
- A
  - Activity LED
    - DX RMS module 42
    - HP/MP RMS module 34
    - LYON RMS module 51
    - MPS-488HP 54
    - MX RMS module 46
    - UltraSeries RMS module 40
  - C
  - Compass control software 5
  - Compass RMS networks 6
    - cabling 11, 21
    - configuration workflow 7
    - design tips for 23
    - specifications 21
    - termination 22
  - Compass RMS software
    - system requirements 6
  - configuration sheet, RMS 69
  - configuring
    - Compass RMS networks, workflow 7
    - email notifications 65
    - external warning relays 12, 64
  - custom twisted-pair connectors 22
  - D
  - DX RMS module 41
    - Identify button 41
    - installing 41
    - Network connectors 42
    - Remote Mute switch 42
    - resetting 42
    - user panel 41
    - Wink/Activity LED 42
  - E
  - email notifications 65
  - Ethernet
    - hubs 22
    - switches 22
  - external muting 61
    - email notifications 65
  - external warning relays 61, 64
    - configuring 64
    - email notifications 65
  - F
  - fire alarm muting 61
  - FTR-120 67
    - installing 67
    - termination 67
    - wiring 68
  - H
  - HP/MP RMS module 29
    - Activity LED 34
    - installing 29
    - Mute Jumper 33, 45
    - Network connectors 34
    - Reset button 34
    - resetting 35
    - Service button 34
    - Service LED 34
    - user panel 34
    - Wink LED 34, 40
  - hubs, Ethernet 22
  - I
  - Identify button
    - DX RMS module 41
    - LYON RMS module 51
    - MPS-488HP 53
    - MX RMS module 46
  - iLON hardware 5
    - transitioning from 7
  - installing
    - DX RMS module 41
    - FTR-120 67
    - LYON RMS module 49
    - MP/HP RMS module 29
    - Mute Jumper
      - HP/MP RMS module 33, 45
      - UltraSeries RMS module 39
    - MX RMS module 43
    - UltraSeries RMS module 38
  - IPv4 address
    - computer 57
    - RMServer 58
  - L
  - loudspeakers
    - DX RMS module 41
    - HP/MP RMS module 29
    - LYON RMS module 49
    - Mute Jumper
      - HP/MP RMS module 33, 45
      - UltraSeries RMS module 38
    - MX RMS module 43

---

- Remote Mute switch, DX RMS module 42
- UltraSeries RMS module 37
- LYON RMS module 49
  - Identify button 51
  - installing 49
  - Network connectors 51
  - Neuron ID 51
  - resetting 51
  - user panel 50
  - Wink/Activity LED 51

## M

- MPS-488HP
  - Identify button 53
  - Network connectors 54
  - Neuron ID 54
  - resetting RMS module 54
  - RMS user panel 53
  - Wink/Activity LED 54

## Mute Jumper

- HP/MP RMS module 33, 45
- UltraSeries RMS module 38

muting, external 61

## MX RMS module 43

- Identify button 46
- installing 43
- Network connectors 46
- Neuron ID 34, 40, 42, 46
- resetting 46
- user panel 46
- Wink/Activity LED 46

## N

### Network connectors

- DX RMS module 42
- HP/MP RMS module 34
- LYON RMS module 51
- MPS-488HP 54
- MX RMS module 46
- UltraSeries RMS module 40

### network repeaters 22

- FTR-120 67

### network specifications 21

### network terminators 22

### Neuron ID

- LYON RMS module 51
- MPS-488HP 54
- MX RMS module 34, 40, 42, 46

## R

### Remote Mute switch

- DX RMS module 42

### Reset button

- HP/MP RMS module 34
- UltraSeries RMS module 40

### resetting

- DX RMS module 42
- HP/MP RMS module 35
- LYON RMS module 51
- MPS-488HP 54
- MX RMS module 46
- UltraSeries RMS module 40

### RMS configuration sheet 69

### RMS module 5, 55

- for DX loudspeakers 41
- for HP/MP loudspeakers 29
- for LYON loudspeakers 49
- for MPS-488HP 53
- for MX loudspeakers 43
- for UltraSeries loudspeakers 37
- retrofitting legacy loudspeakers with 7

### RMS user panel

- DX RMS module 41
- HP/MP RMS module 34
- LYON RMS module 50
- MPS-488HP 53
- MX RMS module 46
- UltraSeries RMS module 39

### RMServer 5

- connecting to a remote computer 10
- connecting to loudspeakers 11
- connecting to the MPS-488HP 11
- email notifications 16, 65
- features and functions 9–10
- installation and mounting 10
- inventory 12
- IPv4 address 14, 15
- Recovery mode 18
- relays 12, 16–17, 61, 64
- restarting 18
- updating firmware 17, 18
- verifying IPv4 address 58
- web server 12–18

## S

### Service button

---

- HP/MP RMS module 34
- UltraSeries RMS module 39
- Service LED
  - HP/MP RMS module 34
  - UltraSeries RMS module 39
- specifications for Compass RMS networks 21
- switches, Ethernet 22
- system requirements
  - for Compass RMS software 6
- T
- termination
  - Compass RMS networks 22
  - FTR-120 67
- troubleshooting
  - RMServer 58
- twisted-pair cabling 21
  - custom connectors 22
- U
- UltraSeries RMS module 37
  - Activity LED 40
  - installing 38
  - Mute Jumper 38
  - Network connectors 40
  - Reset button 40
  - resetting 40
  - Service button 39
  - Service LED 39
  - user panel 39
- V
- verifying
  - computer IPv4 address 57
  - network connections with Ping command 58
  - RMServer IPv4 address 58
- W
- Wink LED 6
  - DX RMS module 42
  - HP/MP RMS module 34, 40
  - LYON RMS module 51
  - MPS-488HP 54
  - MX RMS module 46
- wiring
  - FTR-120 68









Meyer Sound Laboratories Inc.  
2832 San Pablo Avenue  
Berkeley, CA 94702

[www.meyersound.com](http://www.meyersound.com)  
T: +1 510 486.1166  
F: +1 510 486.8356

© 2014  
Meyer Sound Laboratories Inc.  
05.222.024.01 A