

LEOPARD™ Compact Linear Line Array Loudspeaker

LEOPARD-M80 Narrow Coverage Compact Linear Line Array Loudspeaker

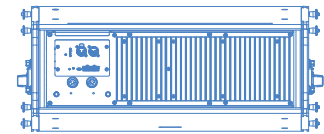
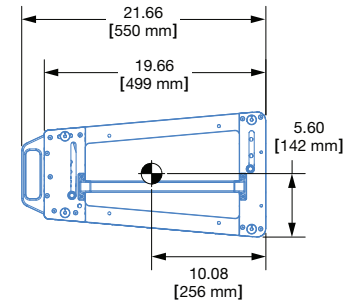
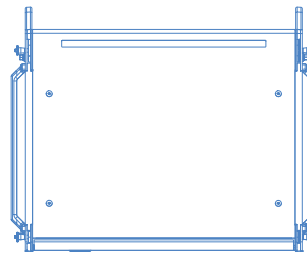
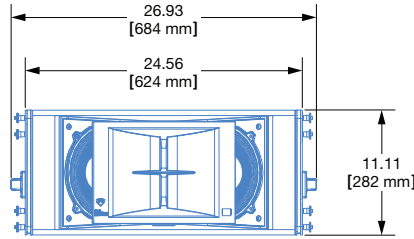

The LEOPARD™ compact linear line array loudspeakers reproduce audio faithfully with tremendous power, superior intelligibility, and extremely low distortion. Rounding out Meyer Sound's award-winning LEO® family of loudspeakers, LEOPARD loudspeakers deliver the same advantages of self-powered design, linear response, and precise directional control as their bigger siblings, LEO-M™ and LYON™.

LEOPARD, with its 110° coverage, breaks new ground in loudspeaker array performance, providing exceptional phase coherence and consistent coverage in a light, compact cabinet, making it extremely versatile. Its innovative amplifier, driver, and horn designs ensure that LEOPARD systems reproduce any sound source with linearity over a wide dynamic range, from speech and classical music to rock and EDM.

The LEOPARD-M80 model provides exceptional phase coherence and extremely accurate and consistent 80° coverage, adding greater flexibility and accuracy to LEOPARD systems. LEOPARD-M80 can be used wherever narrow, more controlled coverage is needed in LEOPARD arrays, such as at the top, or even as the full array in some outfill applications. Because LEOPARD-M80 matches the acoustical characteristics and vertical coverage of LEOPARD, transition is seamless.

Both LEOPARD models are acoustically compatible to LYON and can be used for downfill at the bottom of LYON arrays, and as supplemental sidefill and outfill arrays in bigger LYON systems using the Galileo GALAXY Network Platform's Product Integration settings.¹

LEOPARD loudspeakers offer Native Mode, a configuration optimized to yield excellent system performance right out of the box with minimal external processing. A class D amplifier affords unprecedented efficiency to LEOPARD, significantly lowering distortion while reducing power consumption and operating temperature. A single, field-replaceable module contains the on-board amplifier and control circuitry.

LEOPARD loudspeakers are portable and easy to configure. Their low weight and narrow profile make them well-suited for small- to medium-

sized touring acts and fixed installations, where scalability and ease of rigging are essential.

For low-frequency enhancement, LEOPARD loudspeakers pair with Meyer Sound's 900-LFC low-frequency control element, which can be flown as part of LEOPARD arrays without transition hardware. The 900-LFC shares with LEOPARD the advantages of excellent power-to-size ratio, improved efficiency, and versatility.

In addition to working as a standalone system, LEOPARD can also be used as a supplemental fill loudspeaker in LEO-M and LYON systems. Applications that require more low-frequency headroom can use Meyer Sound's 1100-LFC, which also integrates with LEOPARD systems.

Meyer Sound recommends driving LEOPARD systems with the Galileo® GALAXY Network Platform, which provides 24 bit, 96 kHz audio, matrix routing, alignment, and processing for array components. To guarantee optimum performance, use Meyer Sound's MAPP™ System Design Tool to design LEOPARD systems, as this tool effectively anticipates system SPL and coverage requirements, and also helps verify rigging load ratings.

LEOPARD and 900-LFC loudspeakers work with Meyer Sound's RMS™ remote monitoring system, which provides comprehensive monitoring of system parameters from a Mac® or Windows®-based computer.

LEOPARD loudspeakers include Meyer Sound's QuickFly® rigging with captive GuideALinks™ that facilitate easy setting of splay angles from 0.5° to 15°.

Meyer Sound coats the premium multi-ply birch LEOPARD cabinets with a slightly textured black finish. Options include weather protection and custom color finishes for fixed installations and applications with specific cosmetic requirements. A range of available rigging accessories make LEOPARD loudspeakers a versatile solution for a variety of applications.

FEATURES AND BENEFITS

- Available in two models for greater flexibility: LEOPARD-M80 for narrow controlled array coverage and LEOPARD for wide coverage
- Compact cabinet with small footprint and extraordinary power-to-size ratio
- High peak power output with exceptional linearity and transient reproduction with extremely low distortion at any output level
- Self-powered and Native Mode for super-simplified setup and increased reliability; additional presets for different configurations available in the Galileo GALAXY processor
- Flexible rigging and transport options
- Easy integration using the Galileo GALAXY processor's product integration files for LYON line array loudspeakers and the 900-LFC, 1100-LFC, and VLFC low frequency control elements

APPLICATIONS

- Small- to medium-sized touring and fixed installations
- Clubs, theaters, houses of worship, corporate AV, and theme parks
- Downfill, midfill, sidefill, and outfill for LYON; midfill, sidefill, and outfill for LEO-M

ACCESSORIES

MG-LEOPARD/900 Multipurpose Grid: Flies up to 23 LEOPARD cabinets with a 5:1 safety factor and BGV C1 with some angle restrictions; includes attachment points to accommodate brackets and adapters for lasers and inclinometers. The grid offers multiple and single-center pickup points and supports mixed arrays of LEOPARD and 900-LFC cabinets flown or ground-stacked without any transition hardware. Always use MAPP to verify rigging load ratings.

MCF-LEOPARD Caster Frame: Safely transports up to four fully rigged LEOPARD cabinets, making it easy to assemble and disassemble arrays in blocks. Durable nylon covers for stacks of 3 and 4 units are also available to ensure the LEOPARD is completely road ready.

MTF-LYON/LEOPARD Transition Frame: With some restrictions, flies up to 10 LEOPARD cabinets at a 5:1 safety factor and BGV C1 for downfill below LYON arrays; includes rear attachment points for pull-back; collapsible for easy transport on top of LEOPARD stacks. Always use MAPP to verify rigging load ratings.

PBF-LEOPARD Pull-Back Frame: Provides pull-back for extreme downtilt of flown LEOPARD and 900-LFC arrays, and allows additional downtilt in ground-stacked arrays.

MVP Motor Vee Plate: Attaches to MG-LEOPARD/900 grid (and all other LEO family grids) and fine tunes horizontal aim of LEOPARD and 900-LFC arrays.

MG-LEOPARD/900 Ground-stack Tilt Kit: Includes 2 angle feet that attach to the rear of the MG-LEOPARD/900 grid that can add up to 8 degrees of tilt to the entire ground-stack array.

Galileo GALAXY Network Platform: The Galileo GALAXY Network Platform provides state-of-the-art audio control technology for loudspeaker systems with multiple zones. With immaculate sonic performance, it provides a powerful tool set for corrective room equalization and creative fine-tuning for a full range of applications.

MDM-5000 Distribution Module: Offers convenient power distribution and flexible routing of audio, AC power, and RMS to loudspeaker arrays.

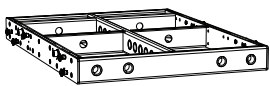

MG-LEOPARD/900 Multipurpose Grid

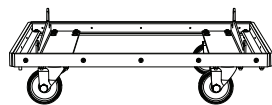

MCF-LEOPARD Caster Frame

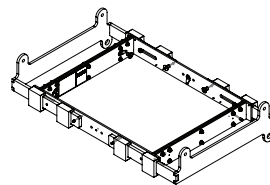

MTF-LYON/LEOPARD Transition Frame

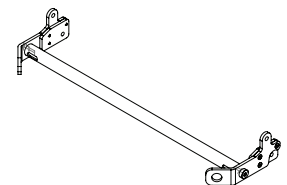

PBF-LEOPARD Pull-Back Frame

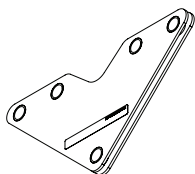

MVP Motor Vee Plate

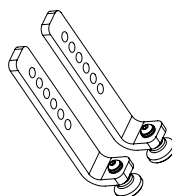

MG-LEOPARD/900 Ground-stack Tilt Kit

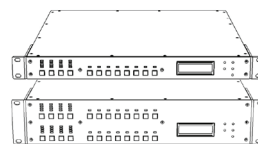

Galileo GALAXY Network Platform

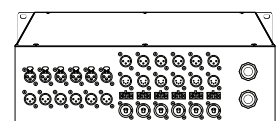

MDM-5000 Distribution Module

SPECIFICATIONS

ACOUSTICAL ²	LEOPARD	LEOPARD-M80
Operating Frequency Range ³	55 Hz – 18 kHz	55 Hz – 18 kHz
Phase Response	92 Hz – 18 kHz ±30 degrees	92 Hz – 18 kHz ±30 degrees
Linear Peak SPL ⁴	133.5 dB with 18 dB crest factor (M-noise) , 130 dB (Pink noise), 134.5 dB (B-noise)	135 dB with 19 dB crest factor (M-noise) , 132 dB (Pink noise), 136.5 dB (B-noise)
COVERAGE	LEOPARD	LEOPARD-M80
Horizontal Coverage	110°	80°
Vertical Coverage	Varies, depending on array length and configuration	
TRANSDUCERS		
Low Frequency	Two 9-inch long-excursion cone drivers; 2 Ω nominal impedance	
High Frequency	One 3-inch diaphragm compression driver coupled to a constant-directivity horn through a patented REM [®] manifold; 4 Ω nominal impedance	
AUDIO INPUT		
Type	Differential, electronically balanced	
Maximum Common Mode Range	±15 V DC, clamped to earth for voltage transient protection	
Connectors	XLR 5-pin female input with male loop output; XLR 3-pin female connectors available to accommodate only balanced audio (no RMS signals)	
Input Impedance	10 kΩ differential between pins 2 and 3	
Wiring ⁵	Pin 1: Chassis/earth through 1 kΩ, 1000 pF, 15 V clamped network to provide virtual ground lift at audio frequencies Pin 2: Signal + Pin 3: Signal - Pin 4: RMS (polarity insensitive) Pin 5: RMS (polarity insensitive) Case: Earth ground and chassis	
Nominal Input Sensitivity	6.0 dBV (2.0 V rms) continuous is typically the onset of limiting for noise and music	
Input Levels	Audio source must be capable of producing +20 dBV (10 V rms) into 600 Ω to produce the maximum peak SPL over the operating bandwidth of the loudspeaker	
AMPLIFIERS		
Type	3-channel, open-loop, class D	
Total Output Power ⁶	3900 W peak	
THD, IM, TIM	< 0.02%	
Cooling	Convection	
AC POWER		
Connector	powerCON 20 input with loop output	
Automatic Voltage Selection	90–265 V AC	
Safety Rated Voltage Range	100–240 V AC, 50–60 Hz	
Turn-on and Turn-off Points	90 V AC turn-on, no turn-off; internal fuse-protection above 265 V AC	
CURRENT DRAW		
Idle Current	0.46 A rms (115 V AC); 0.35 A rms (230 V AC); 0.49 A rms (100 V AC)	
Max Long-Term Continuous Current (>10 sec)	3.0 A rms (115 V AC); 1.5 A rms (230 V AC); 3.4 A rms (100 V AC)	
Burst Current (<1 sec) ⁷	4.4 A rms (115 V AC); 2.3 A rms (230 V AC) 5.5 A rms (100 V AC)	
Maximum Instantaneous Peak Current	12.6 A peak (115 V AC); 6.3 A peak (230 V AC); 14.5 A peak (100 V AC)	
Inrush Current	< 20 A peak	

SPECIFICATIONS, CONT'D.

RMS NETWORK	
	Equipped with two-conductor, twisted-pair network; reports all amplifier operating parameters to host computers
PHYSICAL	
Dimensions	W: 26.93 in (684 mm) x H: 11.11 in (282 mm) x D: 21.66 in (550 mm)
Weight	75 lbs (34.0 kg)
Enclosure	Premium multi-ply birch, slightly textured black finish
Protective Grille	Powder-coated, hex-stamped steel with acoustical black mesh
Rigging	End frames with captive GuideALinks secured with 0.3125 in x 0.63 in quick-release pins that allow 0.5° to 15° splay angles; detachable side and rear handles

NOTES

- See the Galileo GALAXY Network Platform User Guide available at www.meyersound.com/documents/ for more details.
- Loudspeaker system predictions for coverage and SPL are available in Meyer Sound's MAPP System Design Tool.
- Recommended maximum operating frequency range. Response depends on loading conditions and room acoustics.
- Linear Peak SPL** is measured in free-field at 4 m referred to 1 m. Loudspeaker SPL compression measured with M-noise at the onset of limiting, 2-hour duration, and 50 °C ambient temperature is <2 dB.
M-noise is a full bandwidth, (10 Hz–22.5 kHz) test signal developed by Meyer Sound to better measure the loudspeaker's music performance. It has a constant instantaneous peak level in octave bands, a crest factor that increases with frequency, and a full bandwidth Peak to RMS ratio of 18 dB.
Pinknoise is a full bandwidth test signal with Peak to RMS ratio of 12.5 dB.
B-noise is a Meyer Sound test signal used to ensure measurements reflect system behavior when reproducing the most common input spectrum, and to verify there is still headroom over pink noise.
- Pins 4 and 5 (RMS) only included with XLR 5-pin connector that accommodates both balanced audio and RMS signals.
- Peak power based on the maximum unclipped peak voltage the amplifier will produce into the nominal load impedance.
- AC power cabling must be of sufficient gauge so that under burst current rms conditions, cable transmission losses do not cause the loudspeaker's voltage to drop below the specified operating range.

ARCHITECTURAL SPECIFICATIONS

The loudspeaker shall be a compact, self-powered, linear, low-distortion, line array loudspeaker. Its transducers shall include two 9-inch long-excursion cone drivers and one 3-inch diaphragm compression driver coupled to a constant-directivity horn through a patented REM manifold.

The loudspeaker shall incorporate internal processing and a 3-channel, open-loop, class D amplifier. Processing shall include equalization, phase correction, driver protection, and signal division. Performance specifications for a typical production unit shall be as follows, measured at 1/3-octave resolution: operating frequency range shall be 55 Hz–18 kHz; phase response shall be 92 Hz–18 kHz ±30 degrees. Linear peak SPL for the LEOPARD shall be 133.5 dB with 18 dB crest factor; linear peak SPL for the LEOPARD-M80 shall be 135 dB with 19 dB crest factor; both are measured free-field with M-noise at 4 m referred to 1 m.

Audio connectors shall be XLR 3-pin, female and male, accommodating balanced audio, or XLR 5-pin, accommodating both balanced audio and RMS.

The internal power supply shall perform EMI filtering, soft current turn-on,

and surge suppression. Power requirements shall be nominal 100, 110, or 230 V AC line current at 50–60 Hz. UL and CE operating voltage range shall be 100–240 V AC at 50–60 Hz. AC power connectors for input and loop output shall be powerCON 20. Maximum long-term continuous current draw shall be 3.0 A rms at 115 V AC, 1.5 A rms at 230 V AC and 3.4 A rms at 100 V AC. The loudspeaker shall include an RMS remote monitoring system module.

Components shall be mounted in an optimally tuned, vented enclosure constructed of premium multi-ply birch with a slightly textured black finish. The enclosure shall include end frames with captive GuideALinks for linking units in vertical arrays at splay angles from 0.5° to 15°. The front protective grille shall be powder-coated, hex-stamped steel with acoustical black mesh. Dimensions shall be W: 26.93 in (684 mm) x H: 11.11 in (282 mm) x D: 21.66 in (550 mm). Weight shall be 75 lbs (34.0 kg).

The 110° coverage compact linear line array loudspeaker shall be the Meyer Sound LEOPARD. The narrow (80° coverage) compact linear line array loudspeaker shall be the Meyer Sound LEOPARD-M80.