

# 1100-LFC Low-Frequency Control Element

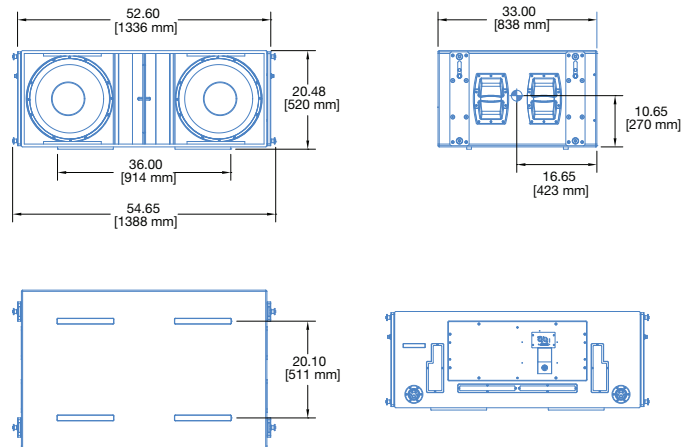

(Shown with optional Quickfly® rigging)



(Dimensions shown for Rigging version)

The 1100-LFC low-frequency control element is a self-powered loudspeaker defined by its sonic linearity in reproducing low-frequency transients at high continuous output levels with very low distortion. This ultra-low distortion, coupled with exceptional headroom and optimized rigging options, makes the 1100-LFC a flexible tool for low-end directional applications for large-scale tours and installations.

To guarantee optimum performance, design 1100-LFC systems with Meyer Sound's MAPP™ system design tool. This intuitive, cross-platform application accurately predicts directional patterns, frequency and impulse responses, and linear peak SPL for 1100-LFC systems, ensuring that systems deliver the required coverage and SPL.

An optimally tuned, vented cabinet houses the 1100-LFC's two 18 in long-excursion cone drivers. The loudspeaker's 28 Hz to 100 Hz operating frequency range complements LEO®, LEOPARD™, LYON™, JM-1P, and other Meyer Sound loudspeakers, allowing it to integrate seamlessly with line arrays and curvilinear arrays.

The unit's power amplifier operates at voltages from 208 to 235 V AC, at 50/60 Hz. TruPower® limiting ensures maximum driver protection, minimizing power compression while yielding high constant output under high continuous and peak power conditions. A single, field-replaceable module located on the rear of the cabinet contains the amplifier, control electronics, and power supply.

The 1100-LFC cabinet includes protective plastic skids on the bottom that securely align with the cabinet's top slots. Units are stackable normally or reversed for cardioid configurations.

Meyer Sound tunes and vents the cabinet to specifically optimize it for low air velocities.

The optional MRK-1100 rigging kit, available as a factory-installed option or field upgrade, includes captive GuideALinks™ that allow the loudspeaker to be flown from the MTG-1100 top grid. Convenient pinned handles and slots make the GuideALinks, located at the front and rear of the cabinet, easy to set. The GuideALinks also accommodate reversed units for flown cardioid arrays.

Suspend line arrays comprising up to 16 cabinets at a 5:1 safety factor and BGC V1 from the optional MTG-1100 top grid. For touring and portable systems, the optional MCF-1100 caster frame accommodates three-cabinet stacking of the 1100-LFC for secure travel. Optionally available durable nylon covers, accommodating stacks of two or three 1100-LFCs, ensure complete road-readiness.

Meyer Sound's RMS™ remote monitoring system comes standard with all 1100-LFCs and provides comprehensive monitoring of system parameters from a host computer running Compass® control software via the RMS™ interface. Convenient 5-pin XLR connectors allow the use of composite cables carrying both balanced audio and RMS signals (3-pin XLR audio connectors are optionally available).

Meyer Sound constructs the 1100-LFC cabinet with premium multi-ply birch and coats it with a slightly textured black finish. A powder-coated, hex-stamped steel grille with acoustical black mesh protects the unit's drivers. Other options include weather protection and custom color finishes for fixed installations and applications with specific cosmetic requirements.

## FEATURES AND BENEFITS

---

- High peak power output with low-frequency clarity and excellent transient reproduction at extreme levels
- Linearity ensures low-frequency output with consistent directional properties in a variety of configurations at any level
- Tuned, vented cabinet optimized for low air velocities
- Stackable and flyable in regular and cardioid arrays
- Seamlessly integrates with LEO, LYON, LEOPARD, and other Meyer Sound loudspeakers

## APPLICATIONS

---

- Stadiums
- Arenas
- Concert halls
- High-power, controlled-directivity arrays

## ACCESSORIES

---

**MRK-1100 Rigging Kit:** Allows the 1100-LFC to be flown from the MTG-1100 grid; includes four captive GuideALinks and eight quick-release pins.

**MTG-1100 Top Grid:** With some restrictions, flies up to 16 1100-LFCs at a 5:1 safety factor and BGV C1; accommodates a variety of pickup configurations with six pickup points; includes attachment points to accommodate brackets and adapters for lasers and inclinometers. Always use MAPP to verify rigging load ratings.

**MVP Motor Vee Plate:** Fine tunes the horizontal aim of arrays; compatible with MTG-LEO-M, MTG-LYON, MTG-1100, and MG-LEOPARD/900 grids.

**MAS-1100 Array Spacer:** Placed between cabinets in 1100-LFC arrays to lengthen the array and improve vertical directionality; includes four captive GuideALinks and eight quick-release pins.

**MCF-1100 Caster Frame:** Safely transports up to three 1100-LFC cabinets, making it easy to assemble and disassemble arrays in blocks of three cabinets. (The MCF-1100 does not include quick-release pins, because it is secured with the quick-release pins included with the loudspeaker.)

**Galileo GALAXY Network Platform:** The Galileo GALAXY Network Platform provides state-of-the-art audio control technology for loudspeaker systems with multiple zones. With immaculate sonic performance, it provides a powerful tool set for corrective room equalization and creative fine-tuning for a full range of applications. In addition, GALAXY devices' improved Delay Integration lets you combine 1100-LFCs with different Meyer Sound loudspeakers.

**MDM-5000 Distribution Module:** MDM-5000 units conveniently power 1100-LFC systems, routing up to six channels of AC power, balanced audio and RMS signals to the loudspeakers.

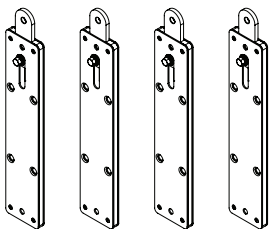

MRK-1100 Rigging Kit

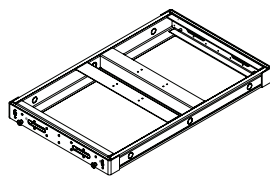

MTG-1100 Top Grid

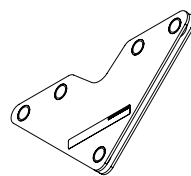

MVP Motor Vee Plate

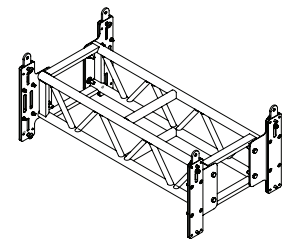

MAS-1100 Array Spacer

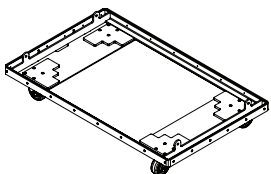

MCF-1100 Caster Frame

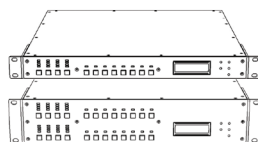

Galileo GALAXY Network Platform

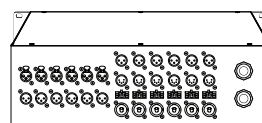

MDM-5000 Distribution Module

## SPECIFICATIONS

ACOUSTICAL <sup>1</sup>	
Operating Frequency Range <sup>2</sup>	28 Hz – 100 Hz
Frequency Response <sup>3</sup>	30 Hz – 85 Hz ±4 dB
Phase Response	34 Hz – 82 Hz ±30°
Linear Peak SPL <sup>4</sup>	<b>140 dB (M-noise)</b> , 140 dB (Pink noise), 141 dB (B-noise)
COVERAGE	
	360° (single unit); varies with number of units and configuration
TRANSDUCERS	
Low Frequency	Two 18 in long-excursion cone drivers; 8Ω nominal impedance
AUDIO INPUT	
Type	Differential, electronically balanced
Maximum Common Mode Range	±15 V DC, clamped to earth for voltage transient protection
Connectors <sup>4</sup>	XLR 5-pin female input with male loop output; XLR 3-pin female connectors available to accommodate only balanced audio (no RMS signals)
Input Impedance	10 kΩ differential between pins 2 and 3
Wiring <sup>5</sup>	Pin 1: Chassis/earth through 220 kΩ, 1000 pF, 15 V clamp network to provide virtual ground lift at audio frequencies Pin 2: Signal + Pin 3: Signal – Pin 4: RMS Pin 5: RMS Case: Earth ground and chassis
Nominal Input Sensitivity	0 dBV (1.0 V rms) continuous is typically the onset of limiting for noise and music
Input Level	Audio source must be capable of producing of +20 dBV (10 V rms) into 600 Ω to produce the maximum peak SPL over the operating bandwidth of the loudspeaker
AMPLIFIER	
Type	2-channel complementary MOSFET output stages (Class AB/H bridged)
Total Output Power <sup>6</sup>	8100 W peak
THD, IM, TIM	< 0.02%
Cooling	Three ultra high-speed primary fans; three ultra high-speed reserve fans
AC POWER	
Connectors	PowerCon32
Automatic Voltage Selection	208–235 V AC, 50/60 Hz
Safety Rated Voltage Range	208–235 V AC, 50/60 Hz
Turn-on and Turn-off Points	165 V AC turn-on; 264 V AC turn-off
CURRENT DRAW	
Idle Current	0.6 A rms (230 V AC)
Maximum Long-Term Continuous Current (>10 sec)	10.5 A rms (230 V AC)
Burst Current (<1 sec) <sup>7</sup>	18 A rms (230 V AC)
Maximum Instantaneous Peak Current	53 A peak (230 V AC)
Inrush Current	< 30 A peak
RMS NETWORK	
	Equipped with two-conductor twisted-pair network, reporting all operating parameters of amplifiers to system operator's host computer.

## SPECIFICATIONS, CONT'D.

PHYSICAL	
Dimensions without Rigging	W: 52.60 in (1336 mm) x H: 20.48 in (520 mm) x D: 33.00 in (838 mm)
Dimensions with Rigging	W: 54.65 in (1388 mm) x H: 20.48 in (520 mm) x D: 33.00 in (838 mm)
Weight without Rigging	249 lb (112.9 kg)
Weight with Rigging	285 lb (129.3 kg)
Enclosure	Premium multi-ply birch with slightly textured black finish
Protective Grille	Powder-coated, hex-stamped steel with acoustical black mesh
Rigging	Optional MRK-1100 rigging kit with captive GuideALinks secured with 0.5 in x 1.25 in quick release pins for ground-stacked, flown, and cardioid configurations

## NOTES

- Loudspeaker system predictions for coverage and SPL are available in Meyer Sound's MAPP System Design Tool.
- Recommended maximum operating frequency range. Response depends on loading conditions and room acoustics.
- Measured in half-space with pink noise at 4 m, 1/3-octave frequency resolution.
- Linear Peak SPL** is measured in half-space at 4 m referred to 1 m. Loudspeaker SPL compression measured with M-noise at the onset of limiting, 2-hour duration, and 50-degree C ambient temperature is < 2 dB.  
**M-noise** is a full bandwidth, (10 Hz–22.5 kHz) test signal developed by Meyer Sound to better measure the loudspeaker's music performance. It has a constant instantaneous peak level in octave bands, a crest factor that increases with frequency, and a full bandwidth Peak to RMS ratio of 18 dB.  
**Pink noise** is a full bandwidth test signal with Peak to RMS ratio of 12.5 dB.  
**B-noise** is a Meyer Sound test signal used to ensure measurements reflect system behavior when reproducing the most common input spectrum, and to verify there is still headroom over pink noise.
- Pins 4 and 5 (RMS) only included with XLR 5-pin connector that accommodates both balanced audio and RMS signals.
- Peak power based on the maximum unclipped voltage the amplifier will produce into the nominal load impedance.
- AC power cabling must be of sufficient gauge so that under burst current rms conditions, cable transmission losses do not cause the loudspeaker's voltage to drop below the specified operating range.

## ARCHITECTURAL SPECIFICATIONS

The loudspeaker shall be a linear, low-distortion, self-powered, low-frequency control element and shall be capable of flown and groundstacked configurations. Its transducers shall include two 18 in long-excursion cone drivers.

The loudspeaker shall incorporate internal processing and a 2-channel Class AB/H amplifier with complementary MOSFET output stages. Protection circuits shall include TruPower limiting. The audio input shall be electronically balanced with a 10 k $\Omega$  impedance and accept a nominal 0 dBV (1.0 V rms) signal (+20 dBV to produce maximum peak SPL).

Audio connectors shall be 5-pin XLR, female and male; 3-pin XLR audio connectors shall be optionally available.

Performance specifications for a typical production unit shall be as follows, measured at 1/3-octave resolution: operating frequency range shall be 28–100 Hz; frequency response shall be 30–85 Hz  $\pm$ 4 dB (measured in half-space with pink noise at 4 m, 1/3-octave frequency resolution); phase response shall be 34–82 Hz  $\pm$ 30 degrees; Linear Peak SPL shall be 140 dB, measured in half-space with M-noise at 4 m referred to 1 m.

The internal power supply shall perform EMI filtering, soft current turn-on, and surge suppression. Power requirements shall be nominal 230 V AC line current at 50 or 60 Hz. UL and CE operating voltage range shall be 208 to 235 V AC. Current draw during burst shall be 18 A rms at 230 V AC. Current inrush during soft turn-on shall not exceed 30 A at 230 V AC. The AC power connector shall be a PowerCon32. The loudspeaker shall include the RMS remote monitoring system module.

Components shall be mounted in an optimally tuned, vented enclosure constructed of premium multi-ply birch and coated with a slightly textured black finish.

Dimensions shall be 52.60 in (1336 mm) wide x 20.48 in (520 mm) high x 33.00 in (838 mm) deep. Dimension with optional rigging shall be 54.65 in (1388 mm) wide x 20.48 in (520 mm) high x 33.00 in (838 mm) deep. Weight shall be 249 lb (112.9 kg). Weight with optional rigging shall be 285 lb (129.3 kg).

The loudspeaker shall be the Meyer Sound 1100-LFC.